

AXOR



NEW PRODUCTS
PRICE BOOK 2024

IMPORTANT - PLEASE READ

This New Products Price Book contains only new products for the year 2024, and is not intended to serve as a comprehensive listing of the full AXOR assortment. To reference the complete assortment with printed books, please use this AXOR New Products Price Book 2024 in combination with AXOR Price Book 2023. Prices and other product data in the 2023 price book will remain valid in the year 2024, with the exception of phase-outs and discontinuations.

As an alternative, we encourage use of the full digital version of AXOR Price Book 2024, as it offers a complete assortment list within one publication, as well as an updated list for phase-out and discontinued models. When released, the resource can be accessed on our ProServices website at pro.hansgrohe-usa.com.

We sincerely appreciate your patience and any additional effort this may require.

Local codes vary, so please check the requirements in your area before installation. Hansgrohe, Inc. recommends that our products be installed only by a licensed plumbing contractor.

- Flow rates for showerheads and handshowers are based on 80 PSI flowing pressure.
- Flow rates for shower trims are based on 45 PSI flowing pressure.
- The thermostat cartridge assembly incorporates a throttle that limits the total output of the thermostatic system to a maximum of 1.75 gpm (6.6 l/min) for those municipalities where it is required by code. The throttle may be removed in areas where it is not required.
- Flow rates for kitchen and lavatory faucets are based on 60 PSI flowing pressure.
- Flow rates for all remaining fittings are based on 45 PSI flowing pressure.



Products displaying "ADA" will meet actuation force requirements outlined in the Americans with Disabilities Act and ICC/ANSI A117.1



Lavatory faucets, showers and handshowers displaying the WaterSense label meet U.S. Environmental Protection Agency criteria for water efficiency. WaterSense labeled products perform as well as or better than their less efficient counterparts.

Hansgrohe, Inc. either owns or has applied for trademark protection from the United States Patent Office for all the product names and features listed below.

Without written consent from Hansgrohe, Inc., you may not use, copy, reproduce or modify any of these marks, and Hansgrohe, Inc. does not intend to give any party license or other interest in any intellectual property rights through distribution of any literature. Additional trademark protection for product names and features not listed in this price book applies as well.

AXOR®
AXOR EDGE™
AXOR ONE®
EcoRight®
hansgrohe®
iBox®
PowderRain®

QuickClean®
Raindance®
Select®
ShowerHeaven®
Techniflex®

Contents

AXOR Suite Sinks & Tubs	17
AXOR Drain	23
AXOR ShowerComposition	29
AXOR ShowerSolutions	37
AXOR One: Matte White	43
AXOR MyEdition: Matte Black	53
AXOR Universal Accessories	59
Circular: Matte White	60
Rectangular: Matte Black	67
AXOR Montreux Accessories:	74
Brushed Gold Optic &	
Brushed Black Chrome	
Price Index	78
Warranty & General Terms	82
Finish Samples: How to Order	90
FinishPlus	5
Ordering Special Finishes	6

The masterly combination of high-tech and craftsmanship

Electroplating



Chrome is the standard surface in the sanitary environment and has proven itself in the bathroom over many decades. Through the electrochemical deposition of various metals, and depending on the type of substrate, a copper layer is built up in the electroplating bath, followed by a bright nickel and chrome layer on the basic brass body.

PVD

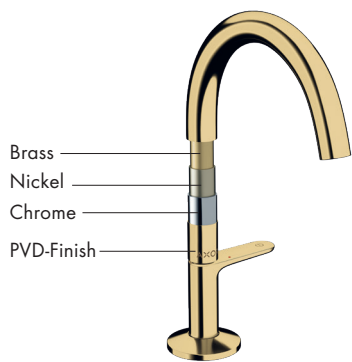

The unmistakable character of the polished and brushed AXOR FinishPlus PVD-surfaces is the result of intensive development, refined in AXOR's in-house vacuum chambers using the physical vapor deposition (PVD) process. The PVD process gives the surfaces an additional metal layer. The vapor deposition of different process gas mixtures creates different light reflections on the surface. The result: exceptional color brilliance and high resistance. In order to reproduce a brushed surface, an additional work step is required in which the surface is textured with a brushing fleece by hand.

Lacquer



The wet-lacquered AXOR FinishPlus surfaces, Matte Black and Matte White, offer a bold color that gives the product a silky, smooth feel and simple elegance.

- / The beneficial properties of PVD surfaces include resistance to scratching, cleaning agents and salty sea air
- / The special textures of the brushed versions are created by hand

Learn more about AXOR FinishPlus:

[axor-design.com](https://www.axor-design.com)

AXOR FINISHPLUS

Standard AXOR Finishes



Chrome
-000
All collections

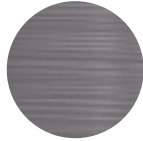

Stainless Steel Optic
-80x
All kitchen collections

Stocked AXOR FinishPlus PVD-Finishes. For specific collections.



Polished Gold Optic
-99x



Brushed Gold Optic
-25x

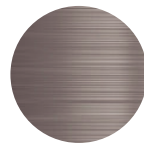

Brushed Nickel
-82x



Polished Nickel
-83x



Polished Black Chrome
-33x

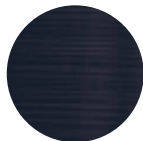

Brushed Black Chrome
-34x



Matte Black
-67x



Matte White
-70x

AXOR FinishPlus. Special Order Finishes.*



Brushed Brass
-95x



Polished Red Gold
-30x



Brushed Red Gold
-31x

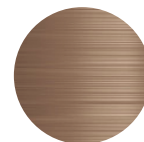

Brushed Bronze
-14x

*See next page for instructions on ordering special finishes.

HOW TO ORDER PRODUCTS IN SPECIAL FINISHES

Applies primarily to the following finishes:

Brushed Brass (-95x), Polished Red Gold (-30x),
Brushed Red Gold (-31x), and Brushed Bronze (-14x)

There is no minimum order quantity on AXOR-branded products. The minimum order quantity is 30 on hansgrohe-branded product, with the exception of the hansgrohe-branded products included in this book. AXOR-branded products contain the word "AXOR" in the description. All remaining products are branded hansgrohe.

To determine which finishes are possible for AXOR-branded products, please refer to the individual product listing in this price book. Please note, not all special finishes can be offered for all products. For hansgrohe-branded products, please contact us at: custom-us@hansgrohe.com.

Initial requests for standard orders or projects must be emailed to: custom-us@hansgrohe.com, including the chrome part number and desired finish. A response will be sent within 2 business days.

PRICING GUIDELINES

- Standard orders – 50% upcharge on the chrome list price. Regular tier discount applies.
- Projects – each job will be quoted individually for a minimum quantity of 30 per part number.

HOW TO ORDER

- After request is confirmed, lead time, quote, and the terms and conditions of sale will be issued by Hansgrohe, Inc.
- Submit customer PO to Hansgrohe, Inc. at custom-us@hansgrohe.com.
- Customer PO must include: the custom quote number issued by Hansgrohe, Inc., including part number provided, and a copy of the signed terms and conditions of sale.

IN-STOCK SPECIAL FINISHES

- Some collections are stocked and ready to ship in Polished Gold Optic, Brushed Gold Optic, Polished Black Chrome, Brushed Black Chrome, Matte Black, and/or Polished Nickel. See individual product listings in this price book to find the special finishes that are readily available for each product model.

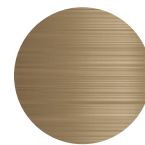

Brushed Brass
-95x



Polished Red Gold
-30x

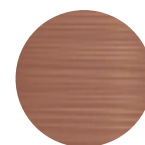

Brushed Red Gold
-31x



Brushed Bronze
-14x



For us, rooms are more than a home. They are sources of inspiration that turn everyday actions into conscious rituals. The objects used in the process reflect not just the taste, but also the personality of their inhabitants.

From personalities –

Our iconic objects for luxury bathrooms and kitchens are created in collaboration with some of the best designers of our time, whose ideas challenge our habits of perception and change our everyday lives. People who live individuality and understand design as an expression of personality.

for personalities

The bathroom and kitchen are among some of our most intimate living spaces, places where we often just take care of ourselves. The element of water we use to do so is a precious commodity. Through outstanding design, we give it a form that unmistakably expresses this appreciation.

Why

SIX REASONS TO CHOOSE AXOR

01 Design diversity

AXOR works with internationally renowned designers. Each uses their individual signature to shape the rich stylistic diversity and product depth of the AXOR portfolio. Their design approaches set standards time and again with regard to their avant-garde forms, which are at once innovative and timeless. Within the framework of AXOR WaterDreams, designers from a broad range of disciplines envision bathrooms of the future, completely independent of product-oriented development. Their ideas provide new momentum for developing the space, understanding how it will be used and creating complementary products.

The following collections feature unique water designs that create extraordinary haptic and visual experiences, with innovative spray types and new ways of presenting water:

- AXOR Starck Organic with a gentle shower jet—a first for a faucet
- AXOR MyEdition with PowderRain, matching the faucet design



02 Individualization

The exclusive AXOR FinishPlus and AXOR Signature services provide individualization, meeting the increasing demands of customers for more options for personalizing bathroom products. With colored PVD surfaces and customized solutions, AXOR products become unmistakably one-of-a-kind.

03 Made in Germany

The outstanding products made in our AXOR factory in Schiltach, Germany, owe their excellence to German engineering quality and a deep commitment to precision in every detail. This expertise draws from over 118 years of collective experience from the Hansgrohe Group, as well as from the knowledge of each production specialist. AXOR is also a pioneer in innovative manufacturing technologies, including a cutting-edge diamond tooling machine that mills the ultra-precise surfaces of the AXOR Edge collection.



04 Worldwide presence

As part of the Hansgrohe Group, which has 32 subsidiaries and 22 sales offices, AXOR is represented worldwide and delivers its products to more than 140 countries. AXOR faucets, showers and kitchen faucets appear in top residences, hotels and restaurants around the world. International architects, planners and builders trust AXOR product quality and consultation with our experts.

05 Understanding sustainability

Using resources wisely is important to AXOR – from water-efficient products to resource-saving material usage in production to durability in design, function and quality. One example: the AXOR Starck Organic wash basin faucet with a remarkably low water consumption.

06 International Design Awards

Validation of our design achievements by independent, internationally renowned industry experts: The numerous awards for top quality product design that AXOR has received since its beginnings confirm the brand's excellence. Among others, these awards include:

- iF Design Award in Gold for AXOR One and AXOR Uno
- Red Dot Best of Best for AXOR Edge



reddot design award

The maximum in services



AXOR FINISHPLUS AND AXOR SIGNATURE

With these individualization services, AXOR fulfills individual customer wishes and the demand for inimitable design.



WEBSITE FOR PROFESSIONALS

In the "pro" portal, specialized dealers, architects and installers can find information, planning advice and prices for all products as well as practical tips and tools for professional bathroom planning and consultation. Find out more at: pro.hansgrohe-usa.com

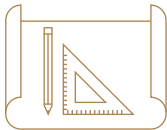

PLANNING INFORMATION

Assembly and service instructions, dimension drawings, BIM planning data and 3D data for optimum bathroom planning with AXOR products can also be found in the "pro" portal: pro.hansgrohe-usa.com



COMFORTZONE-TEST

We use our in-house test center to determine the perfect combinations of faucets and washbasins. In addition, matching washbasins from leading manufacturers are tested with AXOR products for optimum functionality and appearance. All recommended combinations appear on the AXOR website under the corresponding collection page: axor-design.com



MEISTERSERVICE

AXOR service specialists are certified experts in the sanitary trade and provide advice on technical questions by phone, e-mail or chat. In certain cases, a home technology specialist will provide on-site consultation. Local partners can be contacted by phone or e-mail: service@axor-design.com



PROJECT CONSULTATION

AXOR offers professional support and advice for project bidding and planning worldwide. Please contact your local partner or send an e-mail to service@axor-design.com

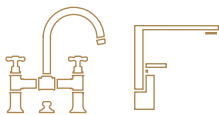

BATHROOM EXHIBITION

Experience AXOR worldwide, live: The WaterStudios, located in global architectural and design centers, provide a source of inspiration and a meeting point, as well as a design and training center for trade partners, architects and interior designers. In the Aquademie at the North America headquarters, visitors and trade partners can experience AXOR live with showcases, trainings, events, and showering with AXOR products in Showerworld.



ONLINE AQUADEMIE

The newly developed Hansgrohe Online Aquademy is accessible via the pro-website. Partners in the trades and crafts benefit from detailed knowledge on all aspects of product and sanitary technology as well as from non-specialist highlights.

Design icons and style diversity

From classic to modern: AXOR faucets, showers, sinks, bathtubs and accessories. Unique, avant-garde pieces and complete collections. Created with world-renowned designers. Uncompromising in quality. Full of pioneering innovations. In pursuit of perfection.



AXOR One



AXOR Edge



AXOR MyEdition



AXOR Starck



AXOR
Starck Organic



AXOR Citterio



AXOR Citterio E



AXOR Citterio M



AXOR Urquiola



AXOR Uno



AXOR Montreux



AXOR Showers



AXOR Accessories



AXOR Electronic faucets



AXOR Sinks and bathtubs



AXOR Kitchen faucets



AXOR Drains



AXOR Basic sets

Uncompromisingly innovative

Pioneering ideas. Shaping water into invigorating jets, enveloping cocoons and sensual flows. Intuitive systems. Simple to use, easy to clean and ecologically responsible. Promoting conscious and conscientious water use.

The result of intensive research and development, AXOR technologies are made in Germany to the highest quality standards – our own. In pursuit of perfection.



AIRPOWER-TECHNOLOGY:

Enriching water with air produces plump droplets for a velvety touch on the skin.



POWDERRAIN-TECHNOLOGY:

The finest silicone nozzles, with several openings per nozzle, provide a uniquely fine mist of water.



QUICKCLEAN-TECHNOLOGY:

Remove limescale deposits quickly and easily with flexible silicone nozzles.



SELECT-TECHNOLOGY:

Use the Select button to switch spray modes or shower heads; turn the water on and off at the faucet.



ECO-RIGHT-TECHNOLOGY:

Faucets and showers that consume up to 60% less water than our conventional products.
More information: pro.hansgrohe.com/your-selling-points/innovative-technologies/ecosmart

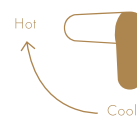

COOLSTART-TECHNOLOGY:

Cold water flows automatically when in the neutral handle position.



COMFORTZONE:

Defines the space between the wash basin and faucet.
The larger the ComfortZone, the greater the variety of uses.

Inspiration and Information

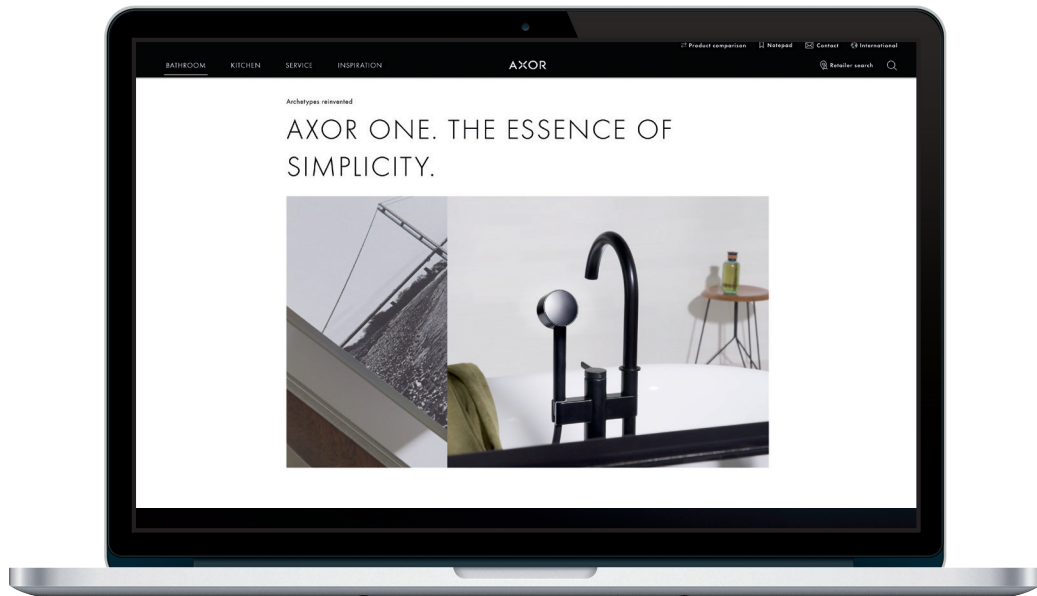

For AXOR, luxury means creating an experience of form and function. One that appeals to the senses and touches people. An experience that begins on the AXOR website. For impressions of and information about all products. For bathroom inspiration and planning. For individualization and refinement possibilities. For background about the brand, the design and the technology.



axor-design.com



AXOR Design



AXOR



axordesign



AXOR



axor.design



AXOR Suite Sinks & Tubs

AXOR Suite Sinks Round Sink Without Overflow

Features of all variants

/ Consists of: wash bowl, design frame
 / Material: SolidSurface
 // Sink inner height: 3 1/8"

/ Material frame: Metal
 / Degree of gloss: Matte
 / Without tap hole

/ Without overflow
 / Pop-up assembly not included

11 3/4"

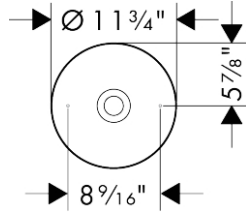

15 3/4"

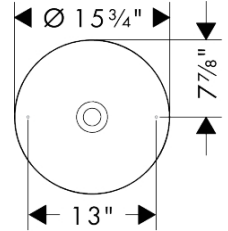

Certificates/declarations



Overview variants

Diameter (in)	Finish	Part No.	List \$	
11 3/4	chrome	42000000	1,700	
	brushed gold optic	42000250	2,244	
	polished black chrome	42000330	2,159	
	brushed black chrome	42000340	2,244	
	matte black	42000670	2,244	
	brushed nickel	42000820	2,244	
	polished gold optic	42000990	2,159	
	AXOR FinishPlus*	42000XX0	2,550	
	15 3/4	chrome	42001000	1,900
		brushed gold optic	42001250	2,508
polished black chrome		42001330	2,413	
brushed black chrome		42001340	2,508	
matte black		42001670	2,508	
brushed nickel		42001820	2,508	
polished gold optic		42001990	2,413	
AXOR FinishPlus*		42001XX0	2,850	

Optional Part

Drain for Sinks



For

Finish	Part No.	List \$
chrome	50001001	86
brushed gold optic	50001251	113
brushed black chrome	50001341	113
matte black	50001671	113
brushed nickel	50001821	113
polished gold optic	50001991	109
AXOR FinishPlus*	50001XX1	129

AXOR Suite Sinks Square Sink Without Overflow

Features of all variants

/ Consists of: wash bowl, design frame
 / Material: SolidSurface
 / Sink inner height: 3 1/8"

/ Material frame: Metal
 / Degree of gloss: Matte
 / Without tap hole

/ Without overflow
 / Pop-up assembly not included

11 1/4 x 11 1/4

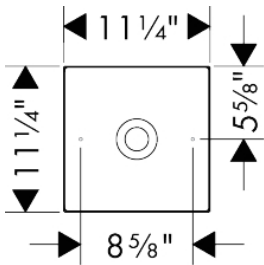

15 3/4 x 15 3/4

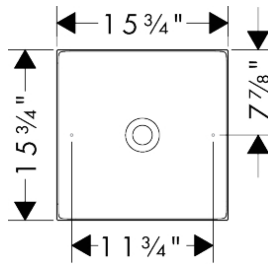

23 5/8 x 15 3/4

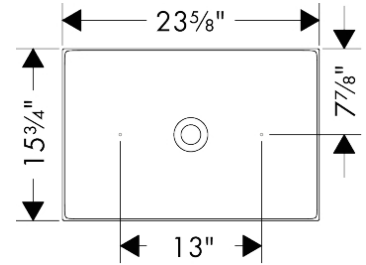

Certificates/declarations



Overview variants









Product dimensions (in)	Finish	Part No.	List \$	
11 1/4 x 11 1/4	chrome	42002000	1,700	
	brushed gold optic	42002250	2,244	
	polished black chrome	42002330	2,159	
	brushed black chrome	42002340	2,244	
	matte black	42002670	2,244	
	brushed nickel	42002820	2,244	
	polished gold optic	42002990	2,159	
	AXOR FinishPlus*	42002XX0	2,550	
	15 3/4 x 15 3/4	chrome	42003000	2,000
		matte black	42003670	2,640
		brushed gold optic	42003250	2,640
polished black chrome		42003330	2,540	
brushed black chrome		42003340	2,640	
brushed nickel		42003820	2,640	
polished gold optic		42003990	2,540	
AXOR FinishPlus*		42003XX0	3,000	

This product listing is continued on the next page. >>

*For additional information please refer to the "special finish" overview.

AXOR Suite Sinks Square Sink Without Overflow (Continued from previous page.)

Overview variants

Product dimensions (in)	Finish	Part No.	List \$
23 5/8 x 15 3/4	 chrome	42004000	2,300
	 matte black	42004670	3,036
	 brushed gold optic	42004250	3,036
	 polished black chrome	42004330	2,921
	 brushed black chrome	42004340	3,036
	 brushed nickel	42004820	3,036
	 polished gold optic	42004990	2,921
	 AXOR FinishPlus*	42004XX0	3,450

Optional Part	For	Finish	Part No.	List \$
 Drain for Sinks		 chrome	50001001	86
		 brushed gold optic	50001251	113
		 brushed black chrome	50001341	113
		 matte black	50001671	113
		 brushed nickel	50001821	113
		 polished gold optic	50001991	109
		 AXOR FinishPlus*	50001XX1	129

AXOR Suite Tub Round with Pop-Up Drain, 74 1/8"

Features

- / Consists of: bathtub, push-open waste set
- / Including overflow set
- / Push open waste set in chosen finish included
- / Filling level: ca. 13 15/16"
- / Material: SolidSurface
- / With overflow
- / Degree of gloss: matte
- / Material thickness: 1/2"
- / Surface length: 66 3/8"
- / Width lying surface: 24 3/4"
- / USA Freestanding bathtub drain kit sold separately. Can be purchased in any plumbing supply store.



Certificates/declarations

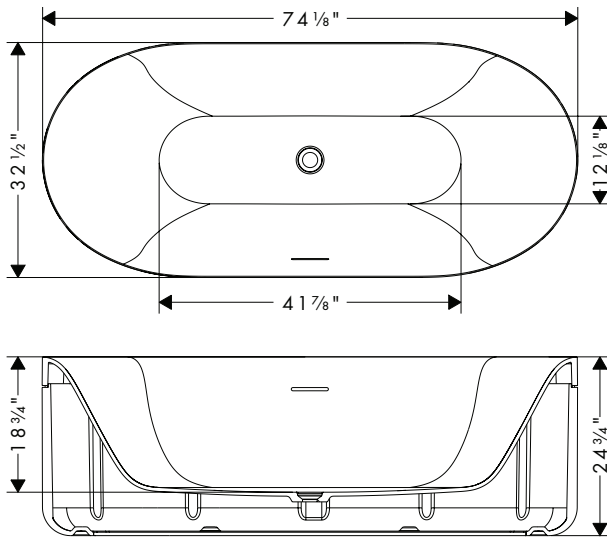

Finish	Part No.	List \$
chrome	42005000	11,000
matte black	42005670	11,000
brushed gold optic	42005250	11,000
polished black chrome	42005330	11,000
brushed black chrome	42005340	11,000
brushed nickel	42005820	11,000
polished gold optic	42005990	11,000
AXOR FinishPlus*	42005XX0	11,000

Optional Parts



Shelf

Finish	Part No.	List \$
chrome	42006000	1,500
matte black	42006670	1,500
brushed gold optic	42006250	1,500
polished black chrome	42006330	1,500
brushed black chrome	42006340	1,500
brushed nickel	42006820	1,500
polished gold optic	42006990	1,500
AXOR FinishPlus*	42006XX0	2,250

*For additional information please refer to the "special finish" overview.

AXOR Suite Tubs Shelf

Features

/ Fastens with screws
/ Material shelf: Metal

/ With mounting material
/ Concealed fastening

/ Maximum load capacity: 44 lb

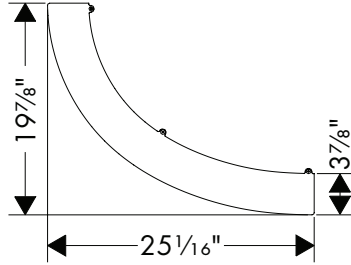

Certificates/declarations



Finish	Part No.	List \$
chrome	42006000	1,500
matte black	42006670	1,500
brushed gold optic	42006250	1,500
polished black chrome	42006330	1,500
brushed black chrome	42006340	1,500
brushed nickel	42006820	1,500
polished gold optic	42006990	1,500
AXOR FinishPlus*	42006XX0	2,250

Required Parts



Round with Pop-Up Drain, 74 1/8"

Finish	Part No.	List \$
chrome	42005000	11,000
matte black	42005670	11,000
brushed gold optic	42005250	11,000
polished black chrome	42005330	11,000
brushed black chrome	42005340	11,000
brushed nickel	42005820	11,000
polished gold optic	42005990	11,000
AXOR FinishPlus*	42005XX0	11,000



AXOR



AXOR



AXOR



AXOR Drain

AXOR Drains for Floor Installation

Features of all variants

- / Consists of: design trim, installation set
- / Mounting type: free in the floor
- / Easy to clean surface
- / Floor thickness: up to 3/4"
- / Suitable for any type of tile
- / Up to 14.0 GPM (53.0 L/Min) drainage capacity
- / Where to use: new construction, renovation
- / Grate removal tool allows easy removal of the trim
- / With integrated slope
- / No visible silicone joint
- / Grate material: Stainless Steel 304 (1.4301)
- / Suitable for primary drainage
- / Suitable for clamp drain or no hub sleeve installation (parts need to be ordered separately)

27 9/16" - 47"

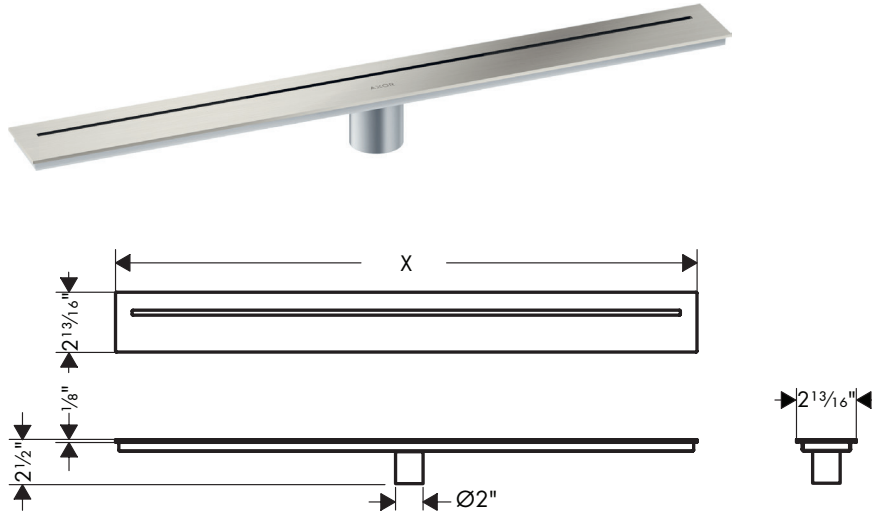

Technologies



Installation



Certificates/declarations



























Overview variants





	Length (in)	Finish	Part No.	List \$		
	27 9/16	chrome	42520001	750		
		brushed gold optic	42520251	990		
		brushed black chrome	42520341	990		
		matte black	42520671	990		
		matte white	42520701	990		
		brushed stainless steel	42520801	750		
		brushed nickel	42520821	990		
		AXOR FinishPlus*	42520XX1	1,125		
			31 1/2	chrome	42521001	800
				brushed gold optic	42521251	1,056
brushed black chrome	42521341			1,056		
matte black	42521671			1,056		
matte white	42521701			1,056		
brushed stainless steel	42521801			800		
brushed nickel	42521821			1,056		
AXOR FinishPlus*	42521XX1			1,200		

This product listing is continued on the next page. >>

AXOR Drains for Floor Installation (Continued from previous page.)

Overview variants

	Length (in)	Finish	Part No.	List \$
	35 7/16	 chrome	42522001	850
		 brushed gold optic	42522251	1,122
		 brushed black chrome	42522341	1,122
		 matte black	42522671	1,122
		 matte white	42522701	1,122
		 brushed stainless steel	42522801	850
		 brushed nickel	42522821	1,122
		 AXOR FinishPlus*	42522XX1	850
	39 3/8	 chrome	42523001	900
		 brushed gold optic	42523251	1,188
		 brushed black chrome	42523341	1,188
		 matte black	42523671	1,188
		 matte white	42523701	1,188
		 brushed stainless steel	42523801	900
		 brushed nickel	42523821	1,188
		 AXOR FinishPlus*	42523XX1	900
	47 1/4	 chrome	42524001	950
		 brushed gold optic	42524251	1,254
		 brushed black chrome	42524341	1,254
		 matte black	42524671	1,254
		 matte white	42524701	1,254
		 brushed stainless steel	42524801	950
		 brushed nickel	42524821	1,254
		 AXOR FinishPlus*	42524XX1	950

 Required Parts (Choose one)		Part No.	List \$
	Rectangular Clamp Drain 2" Cast Iron	05000645	89
	Rectangular Clamp Drain 2" ABS	05000646	75
	Rectangular Clamp Drain 2" PVC	05000647	75
	No Hub Sleeve	87126000	160

AXOR Drains for Wall Installation

Features of all variants

- / Consists of: design trim, installation set, wall installation flange
- / Easy to clean surface
- / Floor thickness: up to 3/4"
- / Suitable for any type of tile

- / Up to 14.0 GPM (53.0 L/Min) drainage capacity
- / Where to use: new construction, renovation
- / Grate removal tool allows easy removal of the trim
- / With integrated slope

- / No visible silicone joint
- / Grate material: Stainless Steel 304 (1.4301)
- / Suitable for primary drainage
- / Suitable for clamp drain or no hub sleeve installation (parts need to be ordered separately)

27 9/16" - 47 1/4"

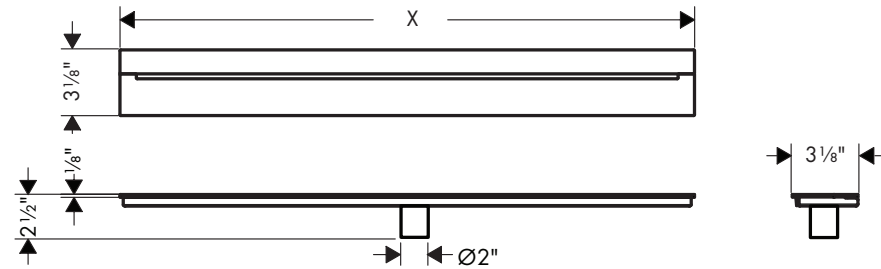

Technologies



Installation



Certificates/declarations



























Overview variants

Length (in)	Finish	Part No.	List \$	
27 9/16	chrome	42525001	750	
	brushed gold optic	42525251	990	
	brushed black chrome	42525341	990	
	matte black	42525671	990	
	matte white	42525701	990	
	brushed stainless steel	42525801	750	
	brushed nickel	42525821	990	
	AXOR FinishPlus*	42525XX1	1,125	
	31 1/2	chrome	42526001	800
		brushed gold optic	42526251	1,056
brushed black chrome		42526341	1,056	
matte black		42526671	1,056	
matte white		42526701	1,056	
brushed stainless steel		42526801	800	
brushed nickel		42526821	1,056	
AXOR FinishPlus*		42526XX1	1,200	

This product listing is continued on the next page. >>

AXOR Drains for Wall Installation (Continued from previous page.)

Overview variants

Length (in)	Finish	Part No.	List \$
35 7/16	 chrome	42527001	850
	 brushed gold optic	42527251	1,122
	 brushed black chrome	42527341	1,122
	 matte black	42527671	1,122
	 matte white	42527701	1,122
	 brushed stainless steel	42527801	850
	 brushed nickel	42527821	1,122
	 AXOR FinishPlus*	42527XX1	1,275
39 3/8	 chrome	42528001	900
	 brushed gold optic	42528251	1,188
	 brushed black chrome	42528341	1,188
	 matte black	42528671	1,188
	 matte white	42528701	1,188
	 brushed stainless steel	42528801	900
	 brushed nickel	42528821	1,188
	 AXOR FinishPlus*	42528XX1	1,350
47 1/4	 chrome	42529001	950
	 brushed gold optic	42529251	1,254
	 brushed black chrome	42529341	1,254
	 matte black	42529671	1,254
	 matte white	42529701	1,254
	 brushed stainless steel	42529801	950
	 brushed nickel	42529821	1,254
	 AXOR FinishPlus*	42529XX1	1,425

AXOR Drain

Required Parts (Choose one)		Part No.	List \$
	Rectangular Clamp Drain 2" Cast Iron	05000645	89
	Rectangular Clamp Drain 2" ABS	05000646	75
	Rectangular Clamp Drain 2" PVC	05000647	75
	No Hub Sleeve	87126000	160

*For additional information please refer to the "special finish" overview.





AXOR ShowerComposition

1-Jet Showerhead Module 110/220

Features of all variants

/ Shower head size: 110 x 220 mm (16 3/4") / Projection 16 3/4"
 / Spray modes: PowderRain / Connection type: basic set

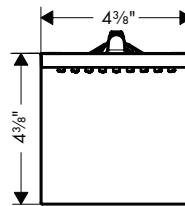
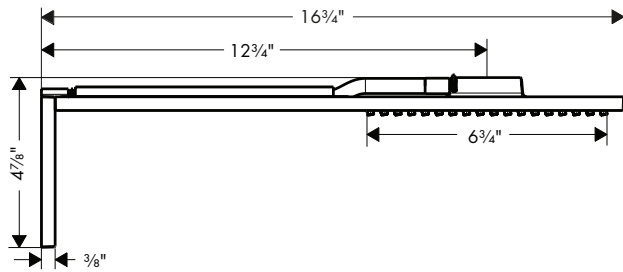

Sustainability



Technologies



Spray Types



Certificates/declarations



Overview variants

Model / Shower head size	Number of spray modes	Spray Modes	Flow rate (gpm)	Finish	Available from	Part No.	List \$
110/220 (16 3/4")	1 spray mode	PowderRain	2.5	chrome	Q3/2024	12592001	1,900
				brushed gold optic	Q3/2024	12592251	2,508
				brushed black chrome	Q3/2024	12592341	2,508
				matte black	Q3/2024	12592671	2,508
				brushed nickel	Q3/2024	12592821	2,508
				AXOR FinishPlus*		12592XX1	2,850
110/220 (16 3/4")	1 spray mode	PowderRain	1.75	chrome	Q3/2024	12791001	1,900
				brushed gold optic	Q3/2024	12791251	2,508
				brushed black chrome	Q3/2024	12791341	2,508
				matte black	Q3/2024	12791671	2,508
				brushed nickel	Q3/2024	12791821	2,508
				AXOR FinishPlus*		12791XX1	2,850



Required Parts

	Part No.	List \$
Rough, Showerhead and Bodyspray	35390181	334

Optional Parts

	For	Finish	Part No.	List \$
 Thermostatic Module Trim for 2 Functions	12592XX1	chrome	12571001	2,800
		brushed gold optic	12571251	3,696
		brushed black chrome	12571341	3,696
		matte black	12571671	3,696
		brushed nickel	12571821	3,696
		AXOR FinishPlus*	12571XX1	4,200

Showerheads with Shoulder Shower

250/250 (9 3/8" x 9 3/8")

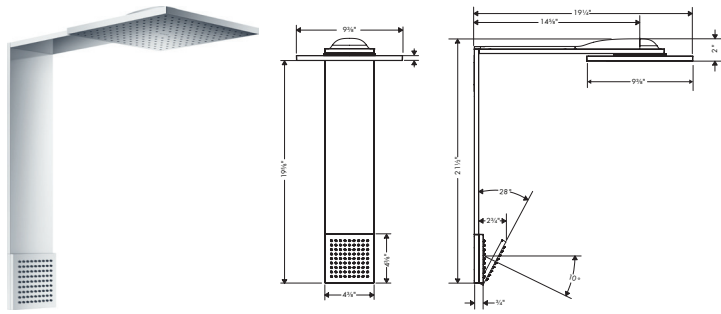

110/220 (16 3/4")

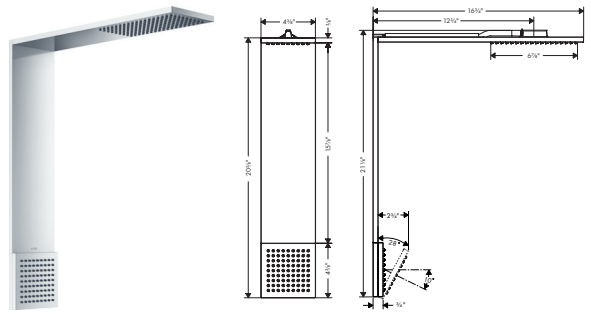

Sustainability



Technologies



Spray Types



Certificates/declarations



Overview variants

Model / Shower head size	Number of spray modes	Shower head Spray mode	Bodyspray Spray mode	Flow rate (gpm)	Length Showerarm (in.)	Finish	Available from	Part No.	List \$
250/250 (9 3/8" x 9 3/8")	2 spray modes	PowderRain, Intense PowderRain	PowderRain	2.5	14 5/8	chrome	Q3/2024	12594001	3,700
						brushed gold optic	Q3/2024	12594251	4,884
						brushed black chrome	Q3/2024	12594341	4,884
						matte black	Q3/2024	12594671	4,884
						brushed nickel	Q3/2024	12594821	4,884
						AXOR FinishPlus*		12594XX1	5,550
250/250 (9 3/8" x 9 3/8")	2 spray modes	PowderRain, Intense PowderRain	PowderRain	1.75	14 5/8	chrome	Q3/2024	12796001	3,700
						brushed gold optic	Q3/2024	12796251	4,884
						brushed black chrome	Q3/2024	12796341	4,884
						matte black	Q3/2024	12796671	4,884
						brushed nickel	Q3/2024	12796821	4,884
						AXOR FinishPlus*		12796XX1	5,550
110/220 (16 3/4")	1 spray mode	PowderRain	PowderRain	2.5	12 3/4	chrome	Q3/2024	12593001	2,900
						brushed gold optic	Q3/2024	12593251	3,828
						brushed black chrome	Q3/2024	12593341	3,828
						matte black	Q3/2024	12593671	3,828
						brushed nickel	Q3/2024	12593821	3,828
						AXOR FinishPlus*		12593XX1	4,350
110/220 (16 3/4")	1 spray mode	PowderRain	PowderRain	1.75	12 3/4	chrome	Q3/2024	12793001	2,900
						brushed gold optic	Q3/2024	12793251	3,828
						brushed black chrome	Q3/2024	12793341	3,828
						matte black	Q3/2024	12793671	3,828
						brushed nickel	Q3/2024	12793821	3,828
						AXOR FinishPlus*		12793XX1	4,350



Required Parts

	For	Part No.	List \$
Rough, Showerhead 3-Jet with Showerarm with 3-way Green Diverter	12594XX1 12796XX1	35358181	800
Rough, Showerhead 2-Jet with Showerarm with 2-way Green Diverter	12593XX1 12793XX1	35361181	763

This product listing is continued on the next page. >>

*For additional information please refer to the "special finish" overview.

Shower modules with shoulder shower (Continued from previous page.)

Optional Parts	For	Finish	Part No.	List \$
 Thermostatic Module Trim for 3 Functions	12594XX1 12796XX1	chrome	12572001	3,300
		brushed gold optic	12572251	4,356
		brushed black chrome	12572341	4,356
		matte black	12572671	4,356
		brushed nickel	12572821	4,356
		AXOR FinishPlus*	12572XX1	4,950
 Thermostatic Module Trim for 2 Functions	12593XX1 12793XX1	chrome	12571001	2,800
		brushed gold optic	12571251	3,696
		brushed black chrome	12571341	3,696
		matte black	12571671	3,696
		brushed nickel	12571821	3,696
		AXOR FinishPlus*	12571XX1	4,200

Shower panels with thermostat and shoulder showerhead

Features of all variants

/ Consists of: Showerhead, shoulder shower, thermostatic shower mixer, shower hose, hand shower, shower holder

// Projection: 16 3/4"
/ Use of outlets: Outlets may be operated simultaneously

/ Connection type: basic set

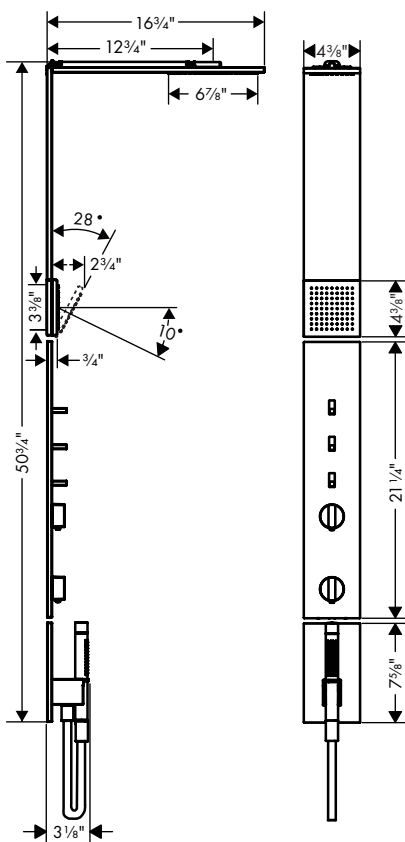

Sustainability



Technologies



Spray Types



Certificates/declarations



This product listing is continued on the next page. >>

Shower Column Set (Continued from previous page.)

Overview variants

Model / Shower head size	Number of spray modes	Shower head Spray mode	Bodyspray Spray mode	Flow rate (gpm)	Finish	Available from	Part No.	List \$
110/220 (16 3/4")	1 spray	PowderRain	PowderRain	2.5	chrome	Q3/2024	12595001	7,800
					brushed gold optic	Q3/2024	12595251	10,296
					brushed black chrome	Q3/2024	12595341	10,296
					matte black	Q3/2024	12595671	10,296
					brushed nickel	Q3/2024	12595821	10,296
					AXOR FinishPlus*		12595XX1	11,700
110/220 (16 3/4")	1 spray	PowderRain	PowderRain	1.75	chrome	Q3/2024	12785001	7,800
					brushed gold optic	Q3/2024	12785251	10,296
					brushed black chrome	Q3/2024	12785341	10,296
					matte black	Q3/2024	12785671	10,296
					brushed nickel	Q3/2024	12785821	10,296
					AXOR FinishPlus*		12785XX1	11,700



AXOR ShowerComposition

Required Parts							Part No.	List \$
Rough for Shower Column							12676181	3,300



*For additional information please refer to the "special finish" overview.

Thermostatic Module Trims

Features of all variants

/ Outlets may be operated simultaneously
 / Sliding movement of handle for switching water on and off, temperature and water flow control

/ T30LV, Start/stop cartridge
 / Flow with Restrictor: 1.75 GPM (6.6 L/Min)
 / Flow without Restrictor: 5.7 GPM (21.5 L/Min)

/ Anti-scald 100° safety stop

3 functions



2 functions



4 functions

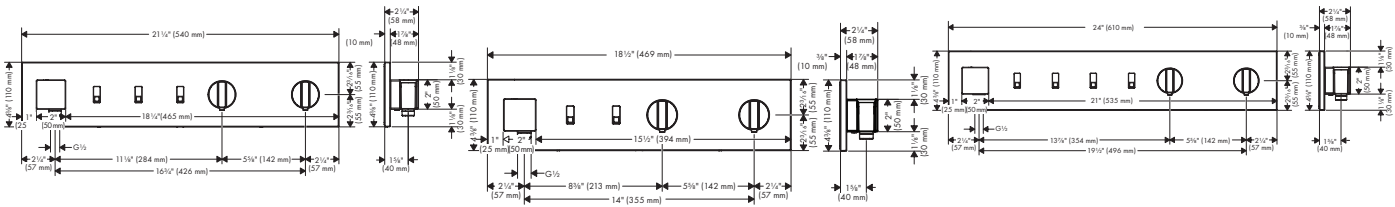

Certificates/declarations





Overview variants















Trim size (in)	Number of functions	Flow rate with restrictor (gpm)	Flow rate without restrictor (gpm)	Finish	Available from	Part No.	List \$
18 1/2 x 4 3/8	2 functions	1.75	5.7	chrome	Q3/2024	12571001	2,800
				brushed gold optic	Q3/2024	12571251	3,696
				brushed black chrome	Q3/2024	12571341	3,696
				matte black	Q3/2024	12571671	3,696
				brushed nickel	Q3/2024	12571821	3,696
				AXOR FinishPlus*		12571XX1	4,200
21 1/4 x 4 3/8	3 functions	1.75	5.7	chrome	Q3/2024	12572001	3,300
				brushed gold optic	Q3/2024	12572251	4,356
				brushed black chrome	Q3/2024	12572341	4,356
				matte black	Q3/2024	12572671	4,356
				brushed nickel	Q3/2024	12572821	4,356
				AXOR FinishPlus*		12572XX1	4,950
24 x 4 3/8	4 functions	1.75	5.7	chrome	Q3/2024	12573001	3,800
				brushed gold optic	Q3/2024	12573251	5,016
				brushed black chrome	Q3/2024	12573341	5,016
				matte black	Q3/2024	12573671	5,016
				brushed nickel	Q3/2024	12573821	5,016
				AXOR FinishPlus*		12573XX1	5,700













See legal note on page 2 for local flow restriction requirements.

This product listing is continued on the next page. >>

Thermostatic Module Trims (Continued from previous page.)

Required Parts		For	Part No.	List \$
	Rough, Thermostatic Module Select for 2 Functions	12571XX1	18310181	1,497
	Rough, Thermostatic Module Select for 3 Functions	12572XX1	18311181	1,746
	Rough, Thermostatic Module Select for 4 Functions	12573XX1	18312181	1,900

Required Parts (choose one)		Finish	Part No.	List \$
	Baton Handshower, 2.5 GPM	 chrome	28703001	350
		 brushed gold optic	28703251	462
		 brushed black chrome	28703341	462
		 matte black	28703671	462
		 brushed nickel	28703821	462
		 AXOR FinishPlus*	28703XX1	525
	Baton Handshower, 1.75 GPM	 chrome	28704001	350
		 brushed gold optic	28704251	462
		 brushed black chrome	28704341	462
		 matte black	28704671	462
		 brushed nickel	28704821	462
		 AXOR FinishPlus*	28704XX1	525

Optional Parts		For	Finish	Part No.	List \$
	Textile Hose with Cylindrical Nut, 49"		 chrome	28228000	100
			 brushed gold optic	28228250	132
			 brushed black chrome	28228340	132
			 matte black	28228670	132
			 brushed nickel	28228820	132
	Baton Handshower, 1.75 GPM	12572XX1	 brushed black chrome	28704341	462
			 AXOR FinishPlus*	28704XX1	525
	Baton Handshower, 2.5 GPM	12572XX1	 brushed black chrome	28703341	462
			 AXOR FinishPlus*	28703XX1	525

For more information about this product, please see the next page.

*For additional information please refer to the "special finish" overview.

Body Spray/Shoulder Shower with Powder Rain

Features of all variants

/ Shower head size: 4 3/8" x 4 3/8"

/ Material: Metal

/ Connection type: Basic set

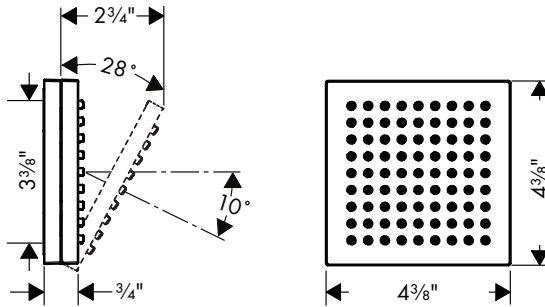

Technologies



Spray Types



Certificates/declarations



Overview variants

Body spray/Shoulder shower size (in)	Number of spray modes	Spray Modes	Flow rate (gpm)	Finish	Available from	Part No.	List \$
4 3/8 x 4 3/8	1 spray mode	PowderRain	2.5	chrome	Q3/2024	12596001	750
				brushed gold optic	Q3/2024	12596251	990
				brushed black chrome	Q3/2024	12596341	990
				matte black	Q3/2024	12596671	990
				brushed nickel	Q3/2024	12596821	990
				AXOR FinishPlus*		12596XX1	1,125
				4 3/8 x 4 3/8	1 spray mode	PowderRain	1.75
brushed gold optic	Q3/2024	12598251	990				
brushed black chrome	Q3/2024	12598341	990				
matte black	Q3/2024	12598671	990				
brushed nickel	Q3/2024	12598821	990				
AXOR FinishPlus*		12598XX1	1,125				
4 3/8 x 4 3/8	1 spray mode	PowderRain	1.5				
				brushed gold optic	Q3/2024	12597251	990
				brushed black chrome	Q3/2024	12597341	990
				matte black	Q3/2024	12597671	990
				brushed nickel	Q3/2024	12597821	990
				AXOR FinishPlus*		12597XX1	1,125

Required Parts



Rough, Showerhead and Bodyspray

Part No. List \$

35390181 334



AXOR ShowerSolutions

AXOR ShowerSolutions Textile Handshower Hoses

Features of all variants

/ High-quality textile hose with braiding
 / Pivot connector prevents hose from tangling
 / Kink-protected

/ Water-resistant and water-repellant material
 / Yarns are made of recycled PET
 / Unique design with multi-colored braided yarns

/ Warm, cotton-like material feels great to the skin
 / Connection thread: G 1/2

Conical and Cylindrical Nut

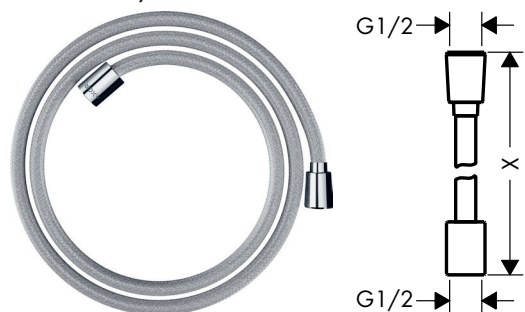

Cylindrical Nut on both sides

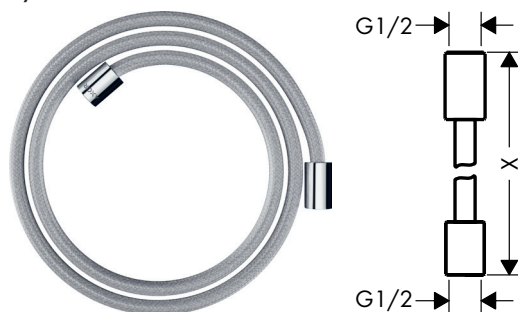

Certificates/declarations







































Overview variants

Model/Version	Length (in)	Finish	Part No.	List \$
1 side conical, 1 side cylindrical	79	chrome	28290000	150
		brushed gold optic	28290250	198
		polished black chrome	28290330	191
		brushed black chrome	28290340	198
		matte black	28290670	198
		brushed nickel	28290820	198
		polished nickel	28290830	191
		polished gold optic	28290990	191
		AXOR FinishPlus*	28290XX0	225
		1 side conical, 1 side cylindrical	63	chrome
brushed gold optic	28259250			165
polished black chrome	28259330			159
brushed black chrome	28259340			165
matte black	28259670			165
brushed nickel	28259820			165
polished nickel	28259830			159
polished gold optic	28259990			159
AXOR FinishPlus*	28259XX0			188

This product listing is continued on the next page. >>

AXOR ShowerSolutions Textile Handshower Hoses (Continued from previous page.)

Overview variants

Model/Version	Length (in)	Finish	Part No.	List \$
1 side conical, 1 side cylindrical	49	 chrome	28227000	100
		 brushed gold optic	28227250	132
		 polished black chrome	28227330	127
		 brushed black chrome	28227340	132
		 matte black	28227670	132
		 brushed nickel	28227820	132
		 polished nickel	28227830	127
		 polished gold optic	28227990	127
		 AXOR FinishPlus*	28227XX0	150
		Cylindrical on both Sides	79	 chrome
 brushed gold optic	28291250			198
 polished black chrome	28291330			191
 brushed black chrome	28291340			198
 matte black	28291670			198
 brushed nickel	28291820			198
 polished nickel	28291830			191
 polished gold optic	28291990			191
 AXOR FinishPlus*	28291XX0			225
Cylindrical on both Sides	63			 chrome
		 brushed gold optic	28261250	165
		 polished black chrome	28261330	159
		 brushed black chrome	28261340	165
		 matte black	28261670	165
		 brushed nickel	28261820	165
		 polished nickel	28261830	159
		 polished gold optic	28261990	159
		 AXOR FinishPlus*	28261XX0	188
		Cylindrical on both Sides	49	 chrome
 brushed gold optic	28228250			132
 polished black chrome	28228330			127
 brushed black chrome	28228340			132
 matte black	28228670			132
 brushed nickel	28228820			132
 polished nickel	28228830			127
 polished gold optic	28228990			127
 AXOR FinishPlus*	28228XX0			150

Trickle Adapter for ADA Hand showers

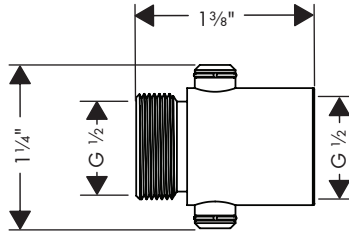

Certificates/declarations



Finish	Available from	Part No.	List \$
chrome	Q3/2024	04998000	60
brushed gold optic	Q3/2024	04998250	79
polished black chrome	Q3/2024	04998330	76
brushed black chrome	Q3/2024	04998340	79
brushed nickel	Q3/2024	04998820	79
polished nickel	Q3/2024	04998830	76
polished gold optic	Q3/2024	04998990	76
AXOR FinishPlus*		04998XX0	90

AXOR ShowerSolutions Wall Outlet with Handshower Holder

Features of all variants

- / Metal housing with internal water supply made of plastic
- / 1/2" NPT
- / For shower hoses with a conical nut

Round

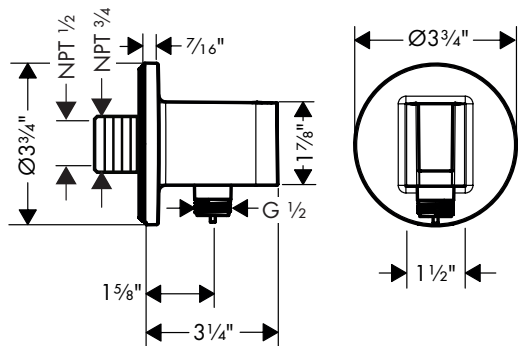

Square

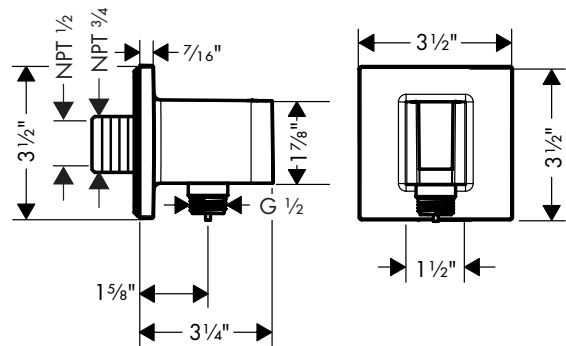











Certificates/declarations



This product listing is continued on the next page. >>

AXOR ShowerSolutions Wall Outlet with Handshower Holder (Continued from previous page.)

Overview variants

Model/Version	Finish	Part No.	List \$
round	 chrome	36733001	325
	 brushed gold optic	36733251	429
	 brushed black chrome	36733341	429
	 matte black	36733671	429
	 brushed nickel	36733821	429
	square	 chrome	36734001
 brushed gold optic		36734251	429
 brushed black chrome		36734341	429
 matte black		36734671	429
 brushed nickel		36734821	429





AXOR One

Single-Hole Faucets Select

Features of all variants

/ Handle variant: Select
 / Spray modes: Aerated spray
 / Flow: 1.2 GPM (4.5 L/Min)

/ Select cartridge for easy, intuitive operation:
 Push handle to turn water on and off, and turn to adjust temperature

170

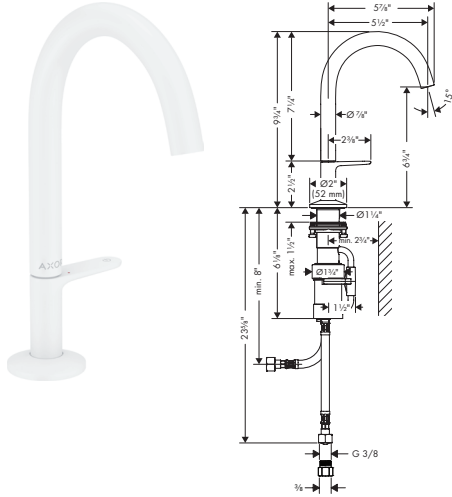

260

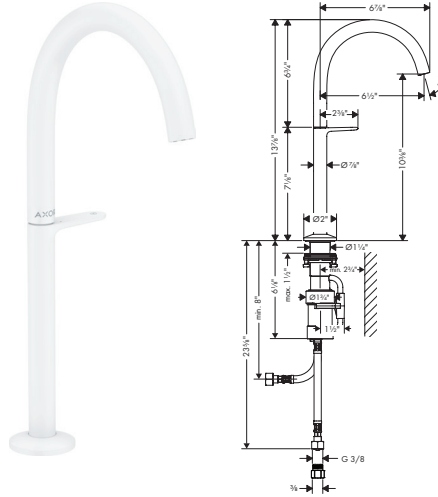

Sustainability



Technologies



Certificates/declarations



Overview variants

	Model	Projection (in)	Finish	Part No.	List \$
	170	5 1/2	matte white	48020701	1,406
			AXOR FinishPlus*	48020XX1	1,597
	260	6 1/2	matte white	48030701	1,827
			AXOR FinishPlus*	48030XX1	2,076

2-Hole Single-Handle Faucet 260, 1.2 GPM

Features

/ Handle variant: Select
 / Swivel range 120°
 / Spray modes: Aerated spray

/ Flow: 1.2 GPM (4.5 L/Min)

/ Select cartridge for easy, intuitive operation:
 Push handle to turn water on and off, and turn to adjust temperature

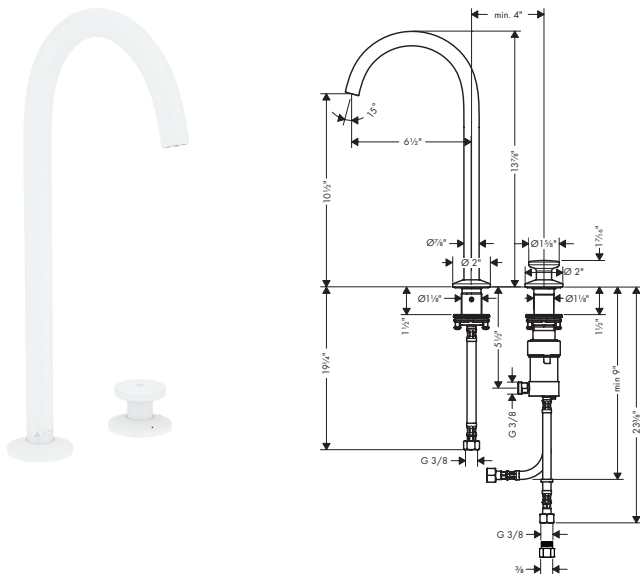

Sustainability



Technologies



Certificates/declarations



	Finish	Part No.	List \$
	matte white	48060701	1,686
	AXOR FinishPlus*	48060XX1	1,915

Single-Hole Faucets

Features of all variants

/ Handle variant: Lever
/ Spray modes: Aerated spray

/ Flow: 1.2 GPM (4.5 L/Min)
/ Ceramic cartridge

70

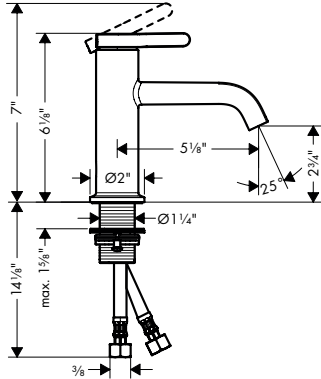

260

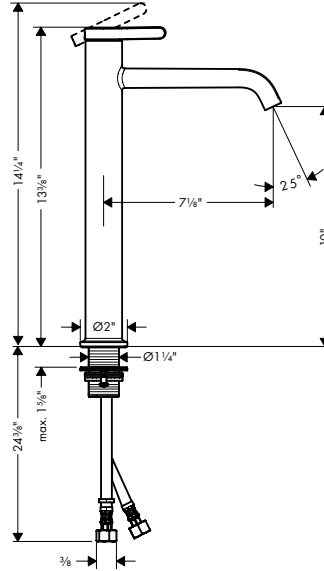

Sustainability



Technologies



Certificates/declarations



Overview variants

	Model	Projection (in)	Drain set	Finish	Part No.	List \$
	70	5 1/8	without	○ matte white	48001701	1,093
				● AXOR FinishPlus*	48001XX1	1,242
	260	7	without	○ matte white	48002701	1,406
				● AXOR FinishPlus*	48002XX1	1,597

Widespread Faucet 170, 1.2 GPM

Features

/ Handle variant: Lever
/ Swivel range 120°

/ Spray modes: Aerated spray
/ Flow: 1.2 GPM (4.5 L/Min)

/ Ceramic valves hot/cold 90°

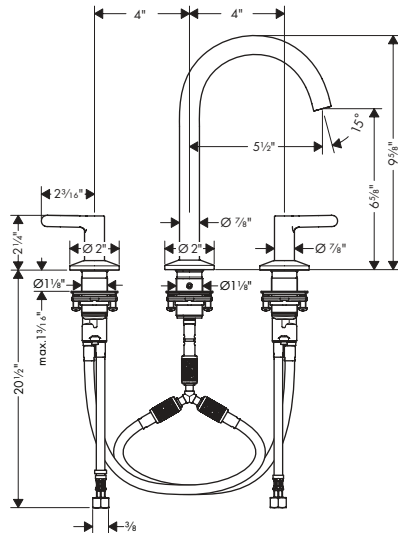

Sustainability



Technologies



Certificates/declarations



	Finish	Part No.	List \$
	○ matte white	48050701	1,827
	● AXOR FinishPlus*	48050XX1	2,076

*For additional information please refer to the "special finish" overview.

Widespread Faucet Select 170

Features

/ Handle variant: Select
 / Swivel range 120°
 / Spray modes: Aerated spray

/ Flow: 1.2 GPM (4.5 L/Min)
 / Right handle: Select cartridge with temperature control

/ Left handle: Volume control

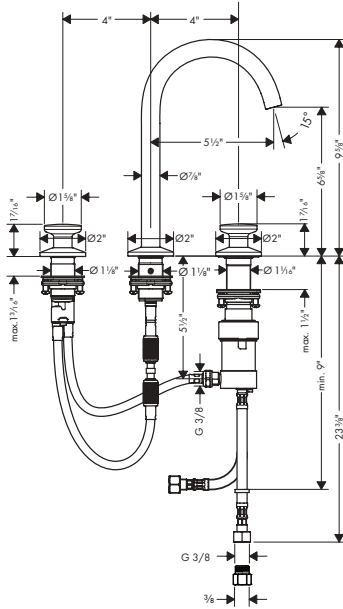

Sustainability



Technologies



Certificates/declarations



Finish	Part No.	List \$
matte white	48070701	2,030
AXOR FinishPlus*	48070XX0	2,307

Wall-Mounted Single-Handle Faucet Select

Features

/ Handle variant: Select
 / Spray modes: Aerated spray
 / Flow: 1.2 GPM (4.5 L/Min)

/ Select cartridge for easy, intuitive operation:
 Push handle to turn water on and off, and turn to adjust temperature

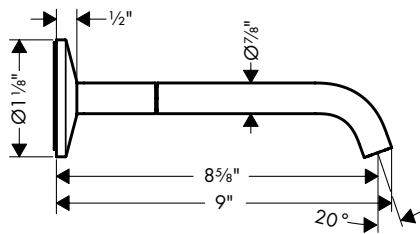

Sustainability



Technologies



Certificates/declarations



Finish	Part No.	List \$
matte white	48112701	1,498
AXOR FinishPlus*	48112XX1	1,702

Thermostatic modules for concealed installation

Features of all variants

/ Comfortable turning on / off of consumers with large Select-paddle

/ Thermostatic cartridge, Start/stop cartridge
/ Anti-scald 100° safety stop

1 function

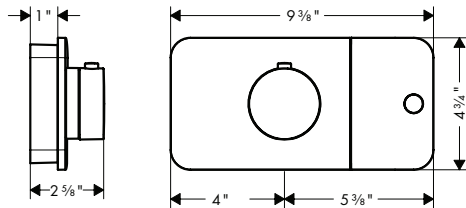

3 functions

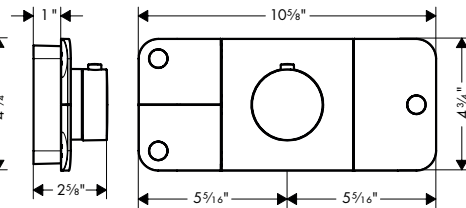

2 functions

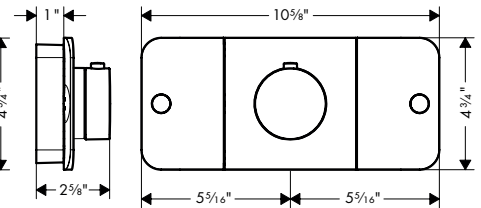

Technologies



Certificates/declarations



Overview variants

Number of functions	Flow rate (gpm) with restrictor	Flow rate (gpm) without restrictor	Finish	Part No.	List \$
1 function	1.75	5.8	○ matte white	45711701	1,914
			● AXOR FinishPlus*	45711XX1	2,175
2 functions	1.75	5.8	○ matte white	45712701	2,082
			● AXOR FinishPlus*	45712XX1	2,365
3 functions	1.75	5.8	○ matte white	45713701	2,290
			● AXOR FinishPlus*	45713XX1	2,602

See legal note on page 2 for local flow restriction requirements.

AXOR One

*For additional information please refer to the "special finish" overview.

Showerhead Diverter Trim

Features

/ Metal escutcheon, handle, sleeve

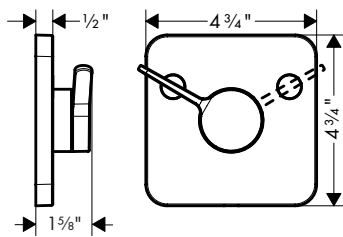

Certificates/declarations



Finish	Available from	Part No.	List \$
matte white	Q2/2024	45772701	559
AXOR FinishPlus*		45772XX1	636

Showerheads 280 2-Jet with Showerarm Trim

Features of all variants

/ Consists of: Showerhead, Showerarm
/ Shower head size: 280 mm (11")
/ Spray modes: PowderRain, Rain

/ Connection of overhead shower: bayonet fixation
/ Showerhead removable for cleaning

/ Connection type: basic set
/ Does not include: Rough

2 spray modes

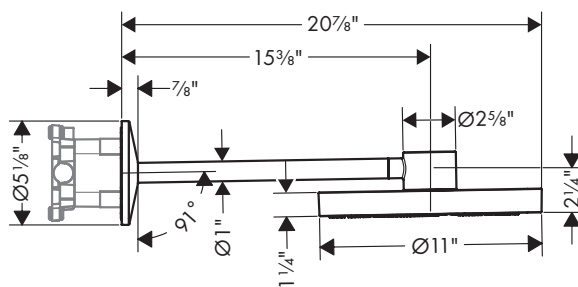

Sustainability



Technologies



Spray Types



Certificates/declarations



Overview variants

Model / Shower head size	Number of spray modes	Spray types	Flow rate (gpm)	Lenght shower arm (in)	Finish	Part No.	List \$
280 (11")	2	PowderRain, Rain	2.5	15	matte white	48481701	2,519
					AXOR FinishPlus*	48481XX1	2,863
280 (11")	2	PowderRain, Rain	1.75	15	matte white	48482701	2,519
					AXOR FinishPlus*	48482XX1	2,863

Required Parts



Rough, Showerhead 2-Jet with Showerarm with 2-way Green Diverter

For

48481XX1
48482XX1

Part No.

35361181

List \$

763

Showerhead 280 2-Jet with Ceiling Mount Trim

Features of all variants

/ Consists of: Showerhead, ceiling connector
 / Shower head size: 280 mm (11")

/ Spray modes: PowderRain, Rain
 / Showerhead removable for cleaning

/ Does not include: Rough

2 spray modes

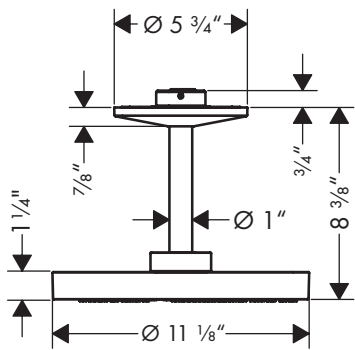

2 spray modes

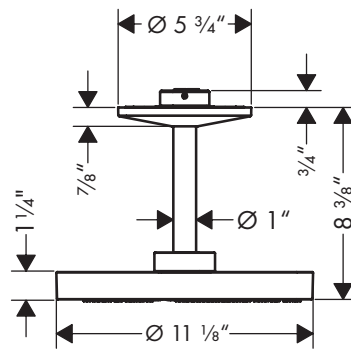

Sustainability



Technologies



Spray Types



Certificates/declarations



Overview variants

Model / Shower head size	Number of spray modes	Spray types	Flow rate (gpm)	Finish	Part No.	List \$
280 (11")	2	PowderRain, Rain	2.5	○ matte white	48483701	2,204
				● AXOR FinishPlus*	48483XX1	2,505
280 (11")	2	PowderRain, Rain	1.75	○ matte white	48484701	2,204
				● AXOR FinishPlus*	48484XX1	2,505

Required Parts



Rough, 2-jet Ceiling Mount Showerhead with 2-way Green Diverter

Part No.	List \$
26434181	689

*For additional information please refer to the "special finish" overview.

Ceiling Extension Pipe for Showerhead 280 2-Jet

Features

/ Length: 14"
/ Solid Brass

/ Ceiling connector, Escutcheon, Mounting
Material, Assembly instructions

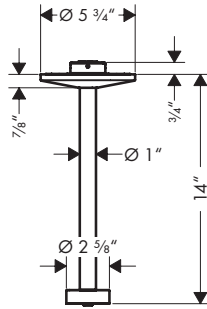

Certificates



Finish	Available from	Part No.	List \$
matte white	Q2/2024	48485701	523
AXOR FinishPlus*		48485USA	594

Showerheads 1-Jet with Shower Arm

Features of all variants

/ Consists of: Showerhead, Showerarm
/ Shower head size: 2.87"

/ Spray modes: PowderRain
/ Projection 4.56"

/ Showerhead removable for cleaning

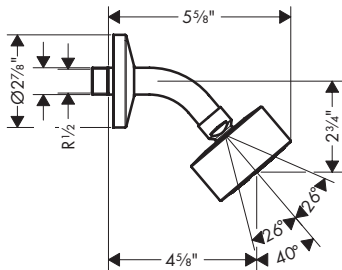

Sustainability



Technologies



Spray Types



Certificates



Overview variants

Model / Shower head size	Number of spray modes	Spray types	Flow rate (gpm)	Finish	Part No.	List \$
75 (2 7/8")	1 spray mode	PowderRain	2.5	matte white	48498701	435
				AXOR FinishPlus*	48498USA	493
75 (2 7/8")	1 spray mode	PowderRain	1.75	matte white	48497701	435
				AXOR FinishPlus*	48497USA	493
75 (2 7/8")	1 spray mode	PowderRain	1.5	matte white	48489701	435
				AXOR FinishPlus*	48489USA	493

Handshowers 1-Jet

Features of all variants

/ Spray modes: PowderRain

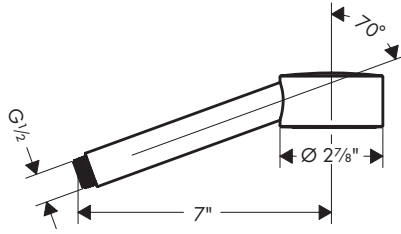

Sustainability



Technologies



Spray Types



Certificates/declarations



Overview variants

Spray head size (in)	Number of spray modes	Spray types	Flow rate (gpm)	Finish	Part No.	List \$
2 7/8	1 spray mode	PowderRain	2.5	○ matte white	48653701	245
				● AXOR FinishPlus*	48653XX1	279
2 7/8	1 spray mode	PowderRain	1.75	○ matte white	48652701	245
				● AXOR FinishPlus*	48652XX1	279
2 7/8	1 spray mode	PowderRain	1.5	○ matte white	48654701	245
				● AXOR FinishPlus*	48654XX1	279

Handshower Holder with Outlet

Features

/ Must be used with hose with cylindrical nut

/ Metal

/ # " NPT

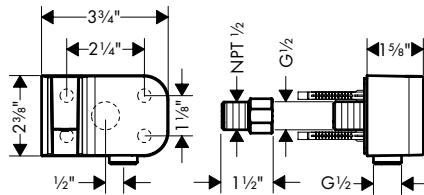

Certificates/declarations



Finish	Available from	Part No.	List \$
○ matte white	Q2/2024	45723701	347
● AXOR FinishPlus*		45723XX1	394

*For additional information please refer to the "special finish" overview.

Wallbar Sets 1-Jet

Features of all variants

- / Consists of: Handshower, Wallbar, Handshower hose, Slider, wall connector
- / Spray modes: PowderRain
- / Wall mounted: Fastens with screws
- / Profile stand pipe: round
- / Shower bar diameter: 1"
- / Pivot connector prevents hose from tangling

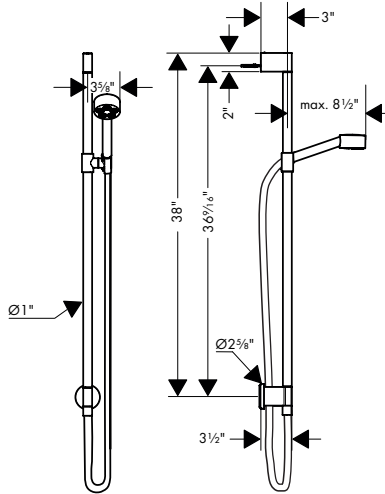

Sustainability



Technologies



Spray Types



Certificates/declarations



Overview variants

Spray head size (in)	Spray types	Flow rate (gpm)	Finish	Part No.	List \$
2 7/8	PowderRain	2.5	○ matte white	48791701	762
			● AXOR FinishPlus*	48791XX1	867
2 7/8	PowderRain	1.75	○ matte white	48793701	762
			● AXOR FinishPlus*	48793XX1	867

Freestanding Tub Filler Trim with 1.75 GPM Handshower

Features

- / Consists of: Freestanding tub filler trim, Handshower, Handshower hose, Handshower holder
- / Spray type mixer: aerated spray
- / Spray type hand shower: PowderRain
- / Flow: 5.5 GPM (20.6 L/Min)
- / Flow rate of hand shower: 1.75 GPM (6.6 L/Min)
- / Ceramic cartridge
- / Diverter with automatic resetting
- / Integrated double backflow prevention

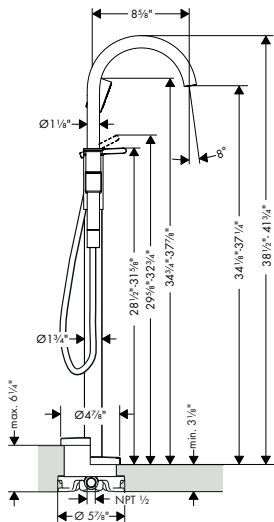

Technologies



Certificates/declarations



Finish	Part No.	List \$
○ matte white	48441701	5,619
● AXOR FinishPlus*	48441XX1	6,385



AXOR

AXOR MyEdition

Single-Hole Faucets

Features of all variants

/ Handle variant: Lever
/ Spray modes: PowderRain

/ Flow: 1.2 GPM (4.5 L/Min)
/ Ceramic cartridge

70 Faucet with Plate



70 Faucet without Plate

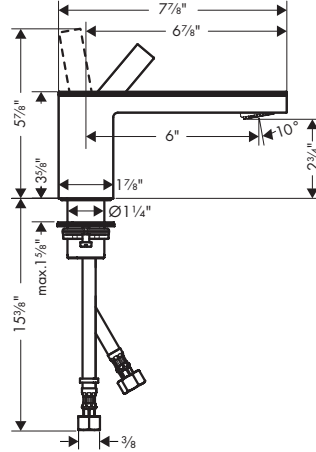

Sustainability



Technologies



Certificates/declarations



230 Faucet with Plate



230 Faucet without Plate

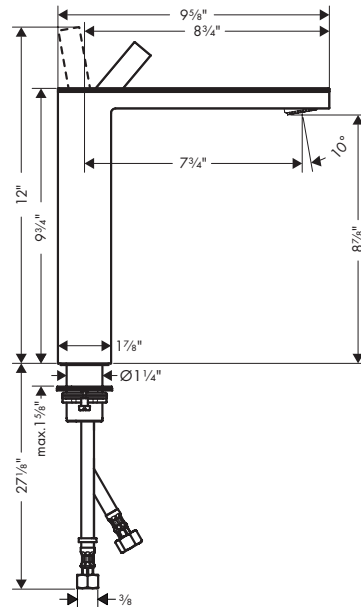

Overview variants

Model	Projection (in)	Cover	Finish	Part No.	List \$
70	6	with Plate	● matte black / black glass	47010671	1,507
70	6	without Plate	● matte black	47012671	1,280
			● AXOR FinishPlus*	47012XX1	1,455
230	7 3/4	with Plate	● matte black / black glass	47020671	1,961
230	7 3/4	without Plate	● matte black	47022671	1,667
			● AXOR FinishPlus*	47022XX1	1,894

Widespread Faucets

Features of all variants

/ Handle variant: Lever
/ Spray modes: PowderRain

/ Flow: 1.2 GPM (4.5 L/Min)
/ Ceramic valves hot/cold 90°

70 with Plate



70 without Plate

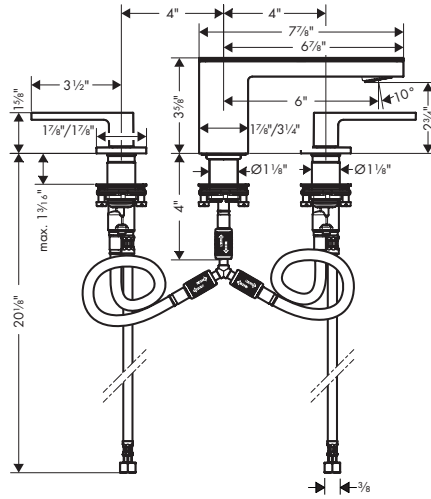
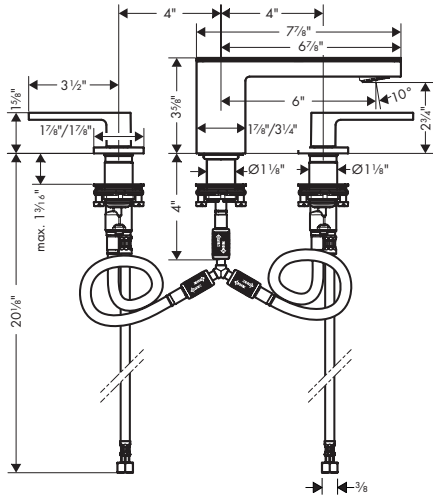

Overview variants

Model	Projection (in)	Cover	Finish	Part No.	List \$
70	6	with Plate	● matte black/black glass	47050671	2,533
70	6	without Plate	● matte black	47052671	2,153
			● AXOR FinishPlus*	47052XX1	2,446

Sustainability



Technologies



Certificates/declarations



Wall-Mounted Single-Handle Faucet

Features of all variants

/ Handle variant: Lever
/ Spray modes: PowderRain

/ Flow: 1.2 GPM (4.5 L/Min)
/ Ceramic cartridge

With plate

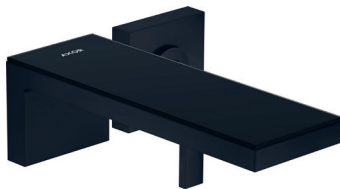

Without plate

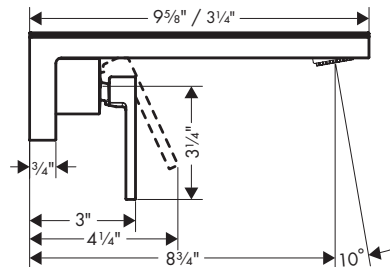

Sustainability



Technologies



Certificates/declarations



For more information about this product, please see the next page.

*For additional information please refer to the "special finish" overview.

Wall-Mounted Single Handle Faucet (Continued from previous page.)

Overview variants

Projection (in)	Cover	Finish	Part No.	List \$
8 3/4	with Plate	● matte black/black glass	47060671	1,280
8 3/4	without Plate	● matte black	47062671	1,090
		● AXOR FinishPlus*	47062XX1	1,239

Freestanding Tub Filler

Features of all variants

- / Spray type mixer: aerated spray
- / Spray type hand shower: Full, IntenseRain
- / Flow: 5.0 GPM (19 L/Min)
- / Flow rate of hand shower: 1.75 GPM (6.6 L/Min)
- / Ceramic cartridge
- / Diverter with automatic resetting
- / Integrated double backflow prevention

With plate



Without plate

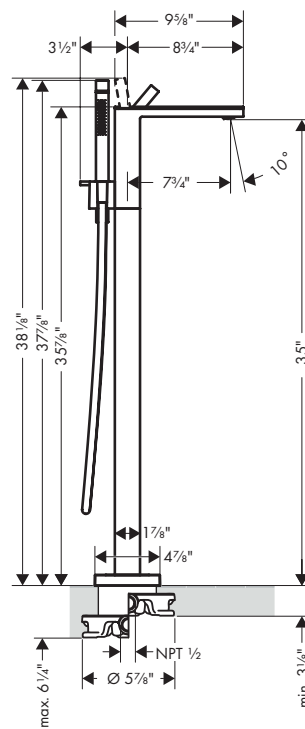

Technologies



Spray Types



Certificates/declarations



Overview variants

Projection (in)	Cover	Finish	Part No.	List \$
7 3/4	with Plate	● matte black/black glass	47440671	4,297
7 3/4	without Plate	● matte black	47442671	3,652
		● AXOR FinishPlus*	47442XX1	4,150

4-Hole Roman Tub Set Trim

Features of all variants

/ Spray type mixer: aerated spray
 / Spray type hand shower: Full, IntenseRain

/ Flow: 6.0 GPM (22.7 L/Min)
 / Ceramic valves hot/cold 90°

/ Diverter with automatic resetting
 / Integrated double backflow prevention

With Plate

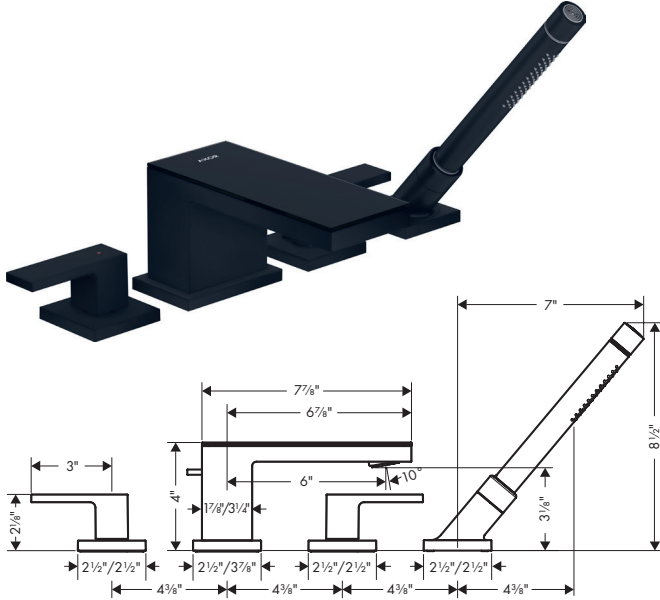

Without plate

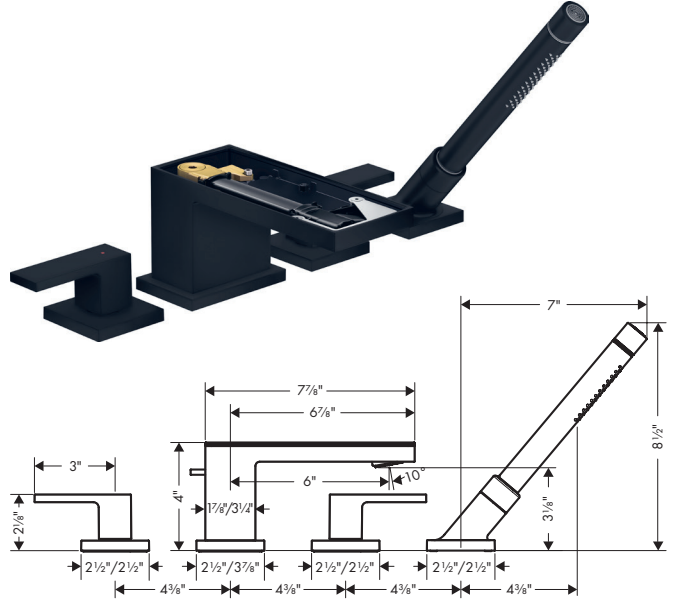

Technologies



Spray Types



Certificates/declarations



Overview variants

Projection (in)	Cover	Finish	Part No.	List \$
6	with Plate	● matte black/black gloss	47430671	4,221
6	without Plate	● matte black	47432671	3,589
		● AXOR FinishPlus*	47432XX1	4,078

Metal Plates

Features of all variants

/ Metal

8"

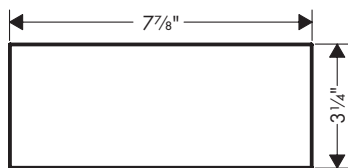

9 5/8"

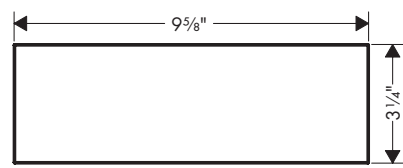

Certificates/declarations





This product listing is continued on the next page. >>

*For additional information please refer to the "special finish" overview.

Metal Plates (Continued from previous page.)

Overview variants

	Length (in)	Finish	Part No.	List \$
	8	 matte black	47903670	253
		 AXOR FinishPlus*	47903XX0	288
	9 5/8	 matte black	47904670	329
		 AXOR FinishPlus*	47904XX0	373



AXOR Universal Accessories

AXOR Universal Circular Toothbrush Tumbler

Features

/ Wall-mounted
/ Metal, Glass

/ Metal holder
/ With mounting material

/ Concealed fastening
/ Diameter of drilled hole: 0.23"

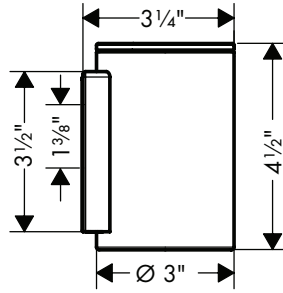

Certificates/declarations



Finish	Part No.	List \$
○ matte white	42804700	360
● AXOR FinishPlus*	42804XX0	409

AXOR Universal Circular Soap dish

Features

/ Wall-mounted
/ With mounting material

/ Concealed fastening
/ Diameter of drilled hole: 0.23"

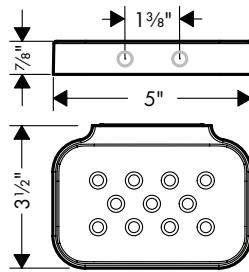

Certificates/declarations



Finish	Part No.	List \$
○ matte white	42805700	312
● AXOR FinishPlus*	42805XX0	355

AXOR Universal Circular Soap dispenser

Features

/ Material container: Metal

/ Type of soap: liquid soap

/ Bottle capacity 10 oz

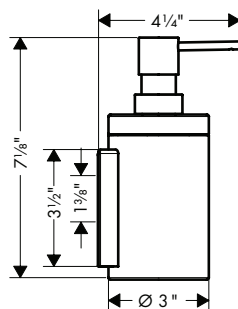

Certificates/declarations



Finish	Part No.	List \$
○ matte white	42810700	407
● AXOR FinishPlus*	42810XX0	462

AXOR Universal Circular Shelf, 16"

Features

/ Wall-mounted
/ Material frame: solid Brass
/ Material shelf: Metal

/ With mounting material
/ Concealed fastening
/ Diameter of drilled hole: 0.23"

/ Suitable for installation inside shower compartment

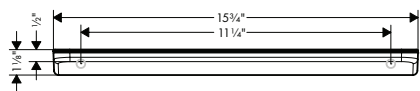

Certificates/declarations



Finish	Part No.	List \$
○ matte white	42844700	578
● AXOR FinishPlus*	42844XX0	657

AXOR Universal Circular Wall Mirror

Features

/ Mirror Glass
/ Material frame: Metal
/ With mounting material

/ Concealed fastening
/ Drilling distance: 10 1/4"
/ Diameter of drilled hole: 0.23"

/ Wall-mounted

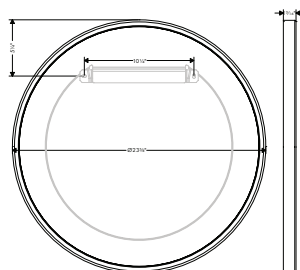

Certificates/declarations



Finish	Part No.	List \$
○ matte white	42848700	1,093

AXOR Universal Circular Shaving Mirror

Features

/ Mirror Glass
/ Material frame: Metal
/ Arms swivel independently

/ With mounting material
/ Concealed fastening
/ Drilling distance: 2"

/ Diameter of drilled hole: 0.23"
/ Wall-mounted

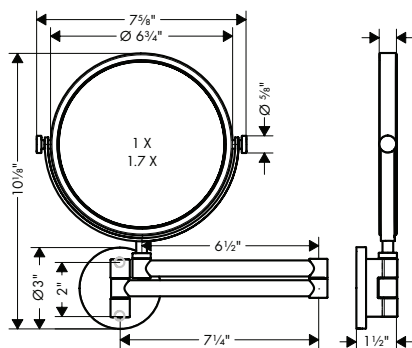

Certificates/declarations



Finish	Part No.	List \$
○ matte white	42849700	844
● AXOR FinishPlus*	42849X0	958

AXOR Universal Circular Towel Ring

Features

/ Wall-mounted
/ Metal
/ Metal holder

/ Swiveling
/ With mounting material
/ Concealed fastening

/ Drilling distance: 1 3/8"
/ Diameter of drilled hole: 0.23"

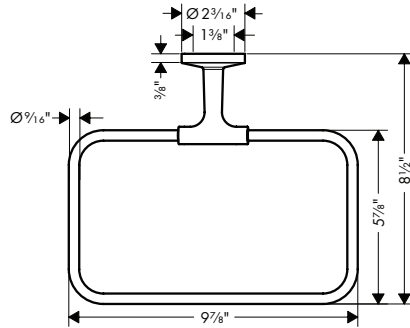

Certificates/declarations



Finish	Part No.	List \$
○ matte white	42823700	360
● AXOR FinishPlus*	42823XX0	409

AXOR Universal Circular Hooks

Features of all variants

/ Wall-mounted
/ Metal

/ With mounting material
/ Concealed fastening

/ Diameter of drilled hole: 0.23"

Single

Double

Certificates/declarations

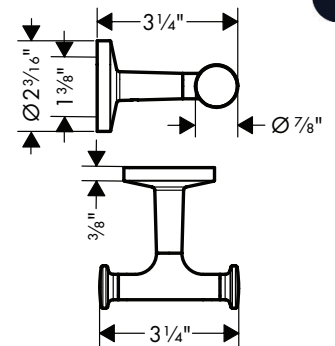
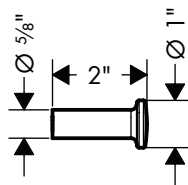

Overview variants

Model/Version	Finish	Part No.	List \$
1 hook	○ matte white	42811700	63
	● AXOR FinishPlus*	42811XX0	70
2 Hooks	○ matte white	42812700	173
	● AXOR FinishPlus*	42812XX0	196

AXOR Universal Circular Towel Bars

Features of all variants

/ Wall-mounted
/ Metal

/ Metal holder
/ With mounting material

/ Diameter of drilled hole: 0.23"
/ Concealed fastening

Single

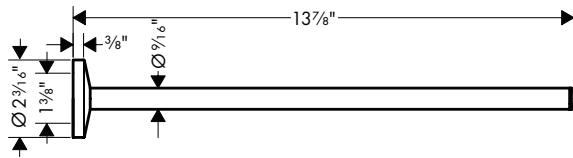
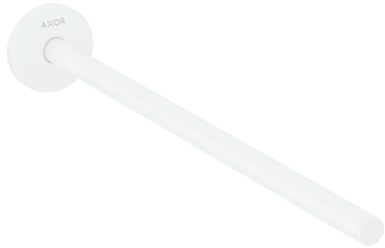

Double

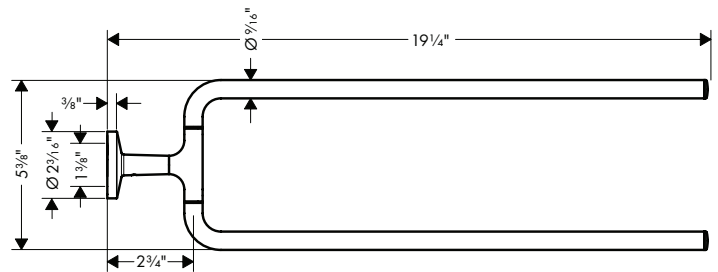

Certificates/declarations



Overview variants

Model / Version	Swiveling	Finish	Part No.	List \$
Single	-	○ matte white	42826700	312
		● AXOR FinishPlus*	42826XX0	355
Double	■	○ matte white	42822700	594
		● AXOR FinishPlus*	42822XX0	675

AXOR Universal Circular Towel Bar, 12"

Features

/ Wall-mounted
/ Metal

/ Metal holder
/ With mounting material

/ Concealed fastening
/ Diameter of drilled hole: 0.23"

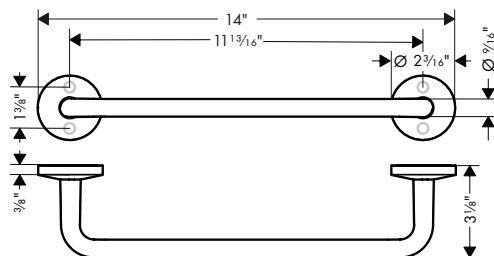

Certificates



Finish	Part No.	List \$
○ matte white	42813700	437
● AXOR FinishPlus*	42813XX0	496

*For additional information please refer to the "special finish" overview.

AXOR Universal Circular Towel Bars

Features of all variants

/ Wall-mounted
/ Metal
/ Metal holder

/ Fixed
/ With mounting material
/ Diameter of drilled hole: 0.23"

/ Concealed fastening

Certificates/declarations



24"

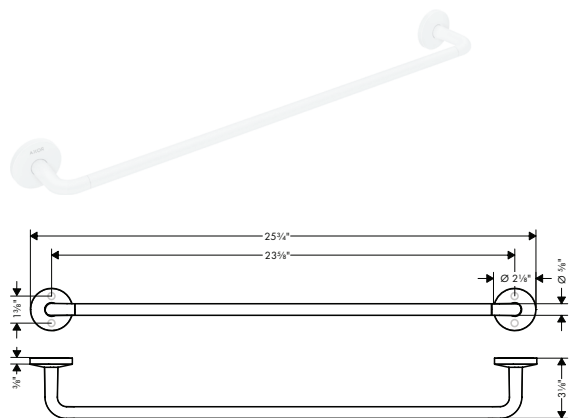

30"

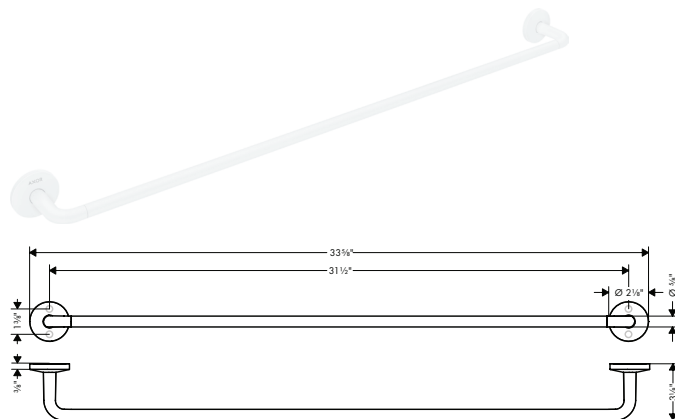

Overview variants

Model / Length (in)	Finish	Part No.	List \$
24	○ matte white	42860700	375
	● AXOR FinishPlus*	42860XX0	426
30	○ matte white	42880700	499
	● AXOR FinishPlus*	42880XX0	567

AXOR Universal Circular Towel Rack, 24"

Features

/ Wall-mounted
/ Metal

/ With mounting material
/ Concealed fastening

/ Diameter of drilled hole: 0.23"

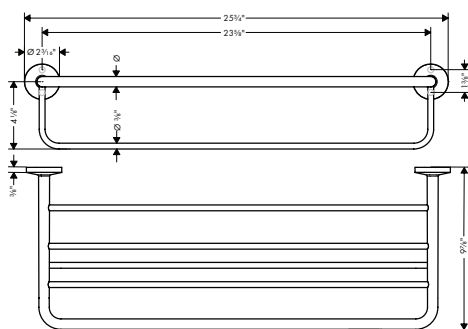

Certificates/declarations



Finish	Part No.	List \$
○ matte white	42843700	812
● AXOR FinishPlus*	42843XX0	922

AXOR Universal Circular Toilet Paper Holders

Features of all variants

/ Wall-mounted
/ Metal

/ With mounting material
/ Concealed fastening

/ Diameter of drilled hole: 0.23"

Certificates/declarations



Single



Double



With cover

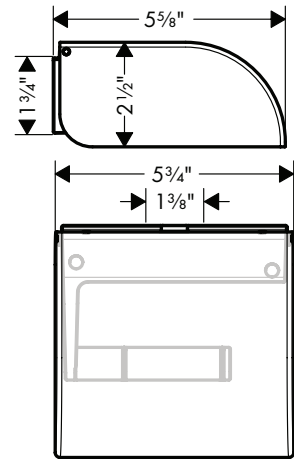
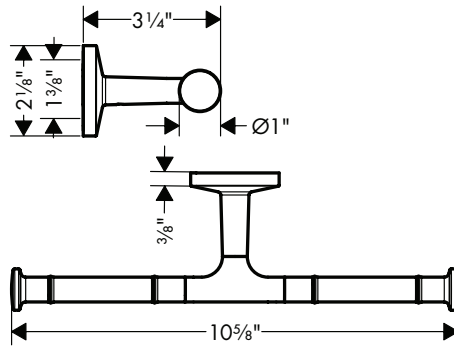
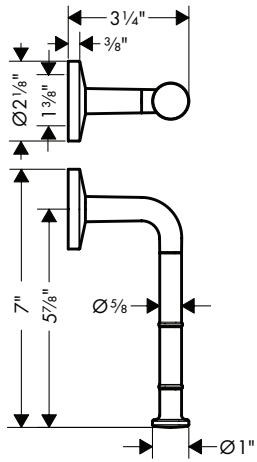

Overview variants

Model/Version	Finish	Part No.	List \$
single	○ matte white	42856700	219
	● AXOR FinishPlus*	42856XX0	249
double	○ matte white	42857700	328
	● AXOR FinishPlus*	42857XX0	373
with cover	○ matte white	42858700	437
	● AXOR FinishPlus*	42858XX0	496

*For additional information please refer to the "special finish" overview.

AXOR Universal Circular Toilet brush holder

Features

/ Wall-mounted
/ Metal
/ Material recess: matt plastic

/ With cover lid
/ With removable insert
/ With mounting material

/ Concealed fastening
/ Diameter of drilled hole: 0.23"

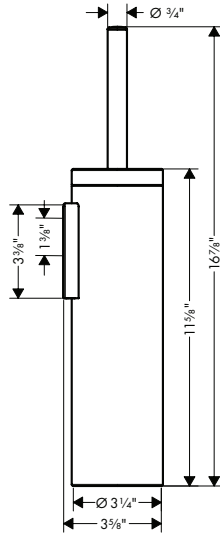

Certificates/declarations



Finish	Part No.	List \$
○ matte white	42855700	499
● AXOR FinishPlus*	42855XX0	567

AXOR Universal Circular Waste Bin

Features

/ Free
/ Material: Metal

/ Material recess: Plastic
/ Capacity: 1.32 gal

/ With removable insert

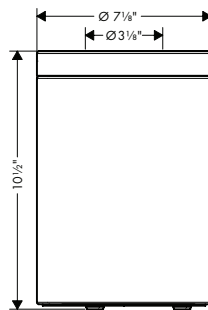

Certificates/declarations



Finish	Part No.	List \$
○ matte white	42872700	469
● AXOR FinishPlus*	42872XX0	532

AXOR Universal Circular Tissue Box

Features

/ Wall-mounted
/ Fastens with screws

/ Metal, Plastic
/ With mounting material

/ Concealed fastening
/ Diameter of drilled hole: 0.23"

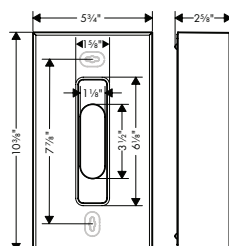

Certificates/declarations



Finish	Part No.	List \$
○ matte white	42873700	250
● AXOR FinishPlus*	42873XX0	283

AXOR Universal Rectangular Toothbrush Tumbler

Features

/ Wall-mounted
/ Metal, Glass

/ Metal holder
/ With mounting material

/ Concealed fastening
/ Diameter of drilled hole: 0.23"

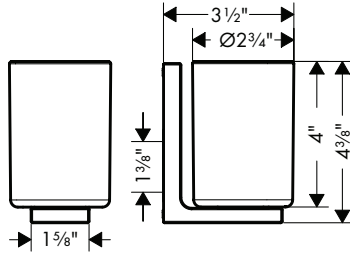

Certificates/declarations



Finish	Part No.	List \$
● matte black	42604670	609
● AXOR FinishPlus*	42604XX0	691

AXOR Universal Rectangular Soap Dish

Features

/ Wall-mounted
/ Material shelf: Glass

/ Metal holder
/ With mounting material

/ Concealed fastening
/ Diameter of drilled hole: 0.23"

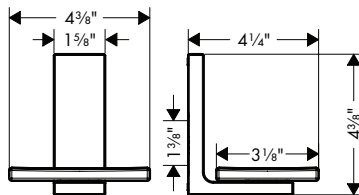

Certificates/declarations



Finish	Part No.	List \$
● matte black	42605670	487
● AXOR FinishPlus*	42605XX0	553

AXOR Universal Rectangular Soap Dispenser

Features

/ Material container: Plastic

/ Type of soap: liquid soap

/ Bottle capacity 20.29 oz

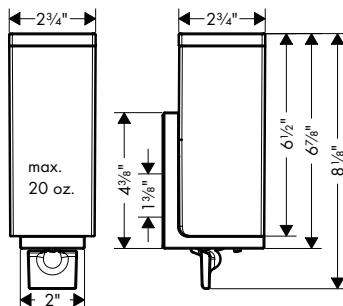

Certificates/declarations



Finish	Part No.	List \$
● matte black	42610670	669
● AXOR FinishPlus*	42610XX0	760

AXOR Universal Rectangular Towel Bars

Features of all variants

/ Wall-mounted
/ Metal

/ Fixed
/ With mounting material

/ Diameter of drilled hole: 0.23"
/ Concealed fastening

Certificates/declarations



Single



Double

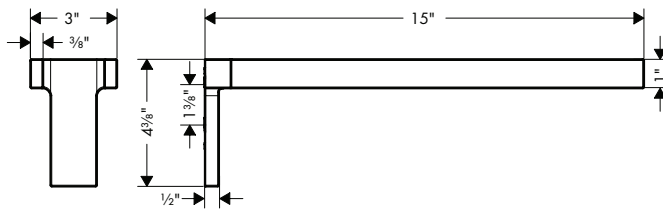
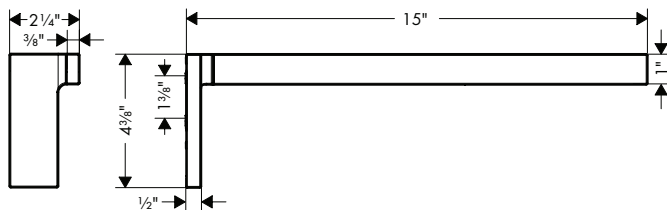

Overview variants

Model / Number of bars	Finish	Part No.	List \$
Single / 1 towel bar	matte black	42626670	578
	AXOR FinishPlus*	42626XX0	657
Double / 2 towel bars	matte black	42622670	882
	AXOR FinishPlus*	42622XX0	1,002

AXOR Universal Rectangular Shower Door Handle

Features

/ Metal
/ Metal holder

/ With mounting material
/ Glass thickness: 0.23" - 0.47"

/ Diameter of drilled hole: 0.23"
/ Concealed fastening

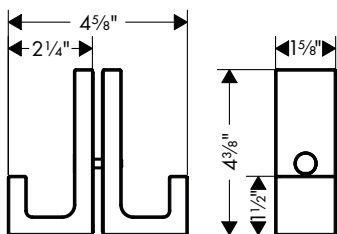

Certificates/declarations



Finish	Part No.	List \$
matte black	42639670	639
AXOR FinishPlus*	42639XX0	726

AXOR Universal Rectangular Shelf, 12"

Features

/ Wall-mounted
/ Material shelf: Metal
/ With mounting material

/ Concealed fastening
/ Diameter of drilled hole: 0.23"

/ Suitable for installation inside shower compartment

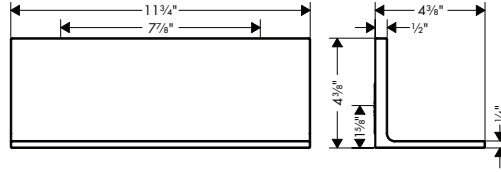

Certificates/declarations



Finish	Part No.	List \$
● matte black	42644670	1,064
● AXOR FinishPlus*	42644XX0	1,209

AXOR Universal Rectangular Shaving Mirror

Features

/ Mirror Glass
/ Material frame: Metal
/ With mounting material

/ Concealed fastening
/ Drilling distance: 1.37"
/ Diameter of drilled hole: 0.23"

/ Wall-mounted

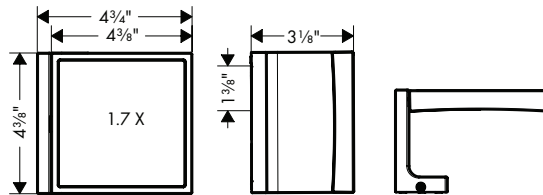

Certificates/declarations



Finish	Part No.	List \$
● matte black	42649670	942
● AXOR FinishPlus*	42649XX0	1,071

AXOR Universal Rectangular Towel Ring

Features

/ Wall-mounted
/ Metal
/ Swiveling

/ With mounting material
/ Concealed fastening
/ Drilling distance: 1.37"

/ Diameter of drilled hole: 0.23"

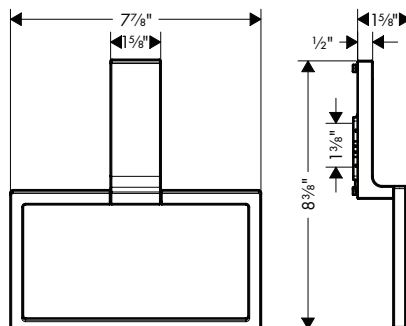
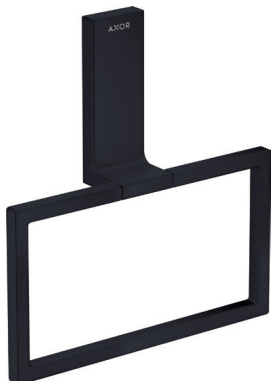

Certificates/declarations



Finish	Part No.	List \$
● matte black	42623670	548
● AXOR FinishPlus*	42623XX0	622

AXOR Universal Rectangular Towel Hook

Features

/ Wall-mounted
/ Metal

/ With mounting material
/ Concealed fastening

/ Diameter of drilled hole: 0.23"

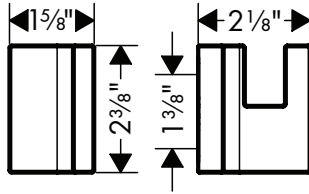

Certificates/declarations



Finish	Part No.	List \$
● matte black	42611670	168
● AXOR FinishPlus*	42611XX0	190

AXOR Universal Rectangular Towel Bar, 12"

Features

/ Wall-mounted
/ Metal
/ With mounting material

/ Concealed fastening
/ Diameter of drilled hole: 0.23"

/ Suitable for installation inside shower compartment

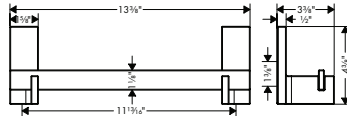

Certificates/declarations



Finish	Part No.	List \$
● matte black	42613670	730
● AXOR FinishPlus*	42613XX0	829

AXOR Universal Rectangular Towel Bars

Features of all variants

/ Wall-mounted
/ Metal

/ With mounting material
/ Diameter of drilled hole: 0.23"

Certificates/declarations



24"

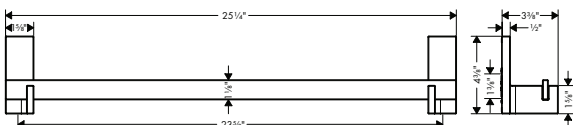

30"

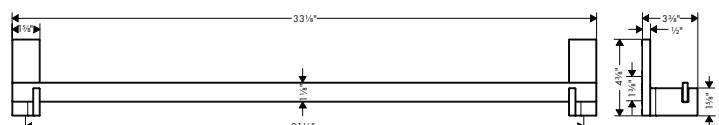

This product listing is continued on the next page. >>

AXOR Universal Rectangular Towel Bars (Continued from previous page.)

Overview variants

Model / Length (in)	Finish	Part No.	List \$
24	● matte black	42661670	851
	● AXOR FinishPlus*	42661XX0	967
30	● matte black	42683670	873
	● AXOR FinishPlus*	42683XX0	1,105

AXOR Universal Rectangular Toilet Paper Holders

Features of all variants

/ Wall-mounted
/ Metal

/ With mounting material
/ Concealed fastening

/ Diameter of drilled hole: 0.23"

Single

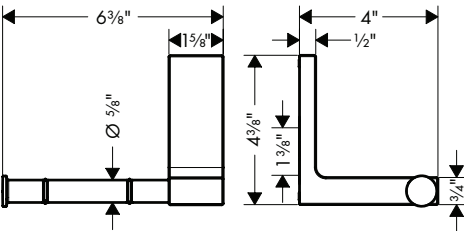

Double

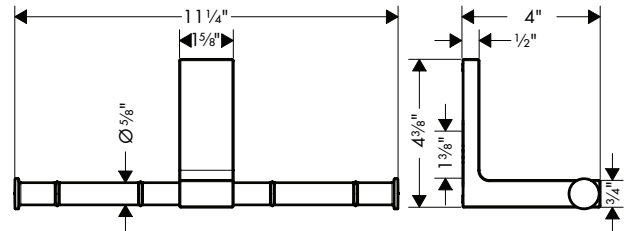

Certificates/declarations



Overview variants

Model/Version	Finish	Available from	Part No.	List \$
single	● matte black	Q2/2024	42656670	441
	● AXOR FinishPlus*		42656XX0	501
double	● matte black	Q2/2024	42657670	578
	● AXOR FinishPlus*		42657XX0	657

*For additional information please refer to the "special finish" overview.

AXOR Universal Rectangular Spare Roll Holder

Features

/ Wall-mounted
/ Metal

/ With mounting material
/ Concealed fastening

/ Diameter of drilled hole: 0.23"

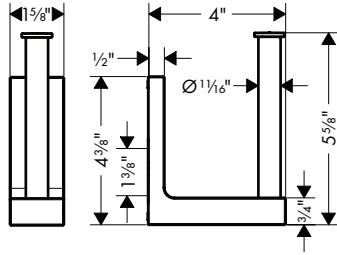

Certificates/declarations



Finish	Part No.	List \$
● matte black	42654670	441
● AXOR FinishPlus*	42654XX0	501

AXOR Universal Rectangular Toilet Brush Holder, Wall-Mounted

Features

/ Wall-mounted
/ Metal
/ With cover lid

/ With removable insert
/ With mounting material
/ Concealed fastening

/ Diameter of drilled hole: 0.23"

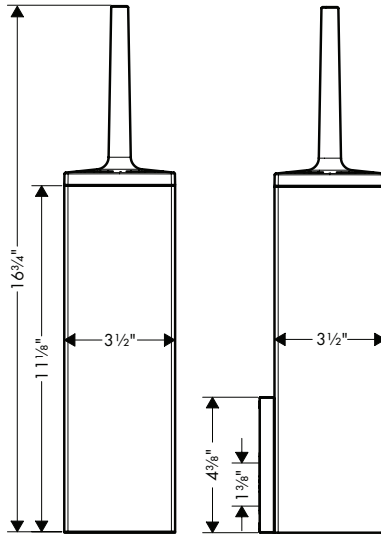

Certificates/declarations



Finish	Part No.	List \$
● matte black	42655670	730
● AXOR FinishPlus*	42655XX0	829



AXOR Montreux Accessories

AXOR Montreux Soap Dispenser

Features

/ Material container: Porcelain
/ Type of soap: liquid soap

/ Bottle capacity 10 oz
/ Concealed fastening

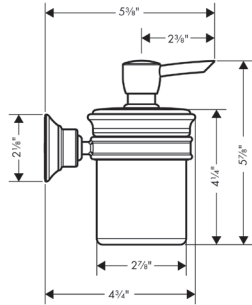

Certificates/declarations



Finish	Part No.	List \$
brushed gold optic	42019250	478
brushed black chrome	42019340	478
AXOR FinishPlus*	42019XX0	543

AXOR Montreux Shaving Mirror

Features

/ Mirror Glass
/ Material frame: Metal
/ Arms swivel independently

/ With mounting material
/ Concealed fastening
/ Drilling distance: 1.37"

/ Diameter of drilled hole: 0.23"
/ Wall-mounted

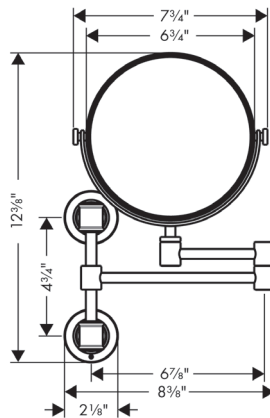

Certificates/declarations



Finish	Part No.	List \$
brushed gold optic	42090250	1,071
brushed black chrome	42090340	1,071
AXOR FinishPlus*	42090XX0	1,218

AXOR Montreux Shower Basket 160/101

Features

/ Wall-mounted

/ With mounting material

/ Diameter of drilled hole: 0.23"

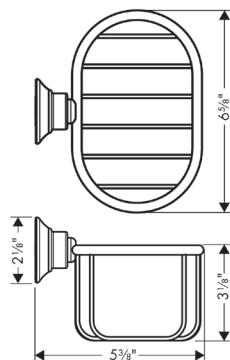
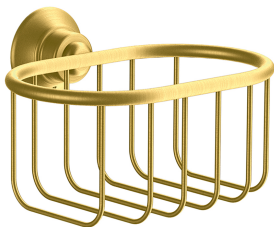

Certificates/declarations



Finish	Part No.	List \$
brushed gold optic	42065250	458
brushed black chrome	42065340	458
AXOR FinishPlus*	42065XX0	520

AXOR Montreux Color Cap Kit Set



Certificates/declarations



Finish	Part No.	List \$
brushed gold optic	16911250	80
brushed black chrome	16911340	135

AXOR Montreux Towel Ring

Features

/ Wall-mounted
/ Metal
/ Metal holder

/ Swiveling
/ With mounting material
/ Concealed fastening

/ Drilling distance: 1.37"
/ Diameter of drilled hole: 0.23"

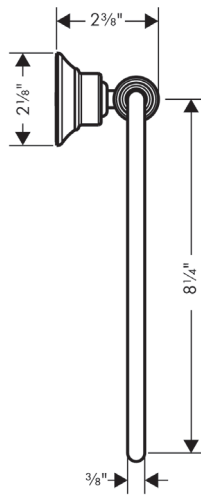

Certificates/declarations



Finish	Part No.	List \$
brushed gold optic	42021250	385
brushed black chrome	42021340	385
AXOR FinishPlus*	42021XX0	438

AXOR Montreux Hook

Features

/ Wall-mounted
/ Metal

/ With mounting material
/ Concealed fastening

/ Diameter of drilled hole: 0.23"

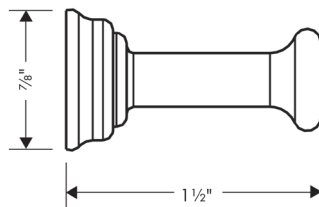
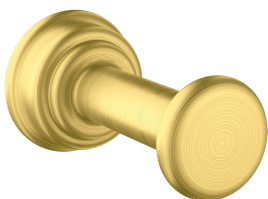

Certificates/declarations



Finish	Part No.	List \$
brushed gold optic	42137250	133
brushed black chrome	42137340	133
AXOR FinishPlus*	42021XX0	151

*For additional information please refer to the "special finish" overview.

AXOR Montreux Towel Bar 12"

Features

/ Wall-mounted
/ Metal

/ Metal holder
/ With mounting material

/ Concealed fastening

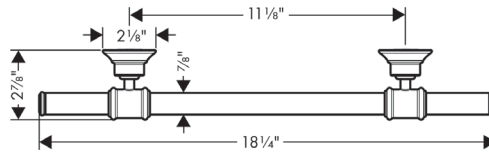

Certificates/declarations



Finish	Part No.	List \$
brushed gold optic	42030250	478
brushed black chrome	42030340	478
AXOR FinishPlus*	42030XX0	543

AXOR Montreux Towel Bar 24"

Features

/ Wall-mounted
/ Metal

/ Metal holder
/ With mounting material

/ Diameter of drilled hole: 0.23"
/ Concealed fastening

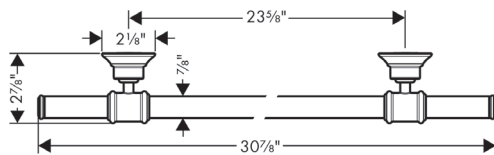

Certificates/declarations



Finish	Part No.	List \$
brushed gold optic	42060250	497
brushed black chrome	42060340	497
AXOR FinishPlus*	42060XX0	564

AXOR Montreux Toilet Paper Holder

Features

/ Wall-mounted
/ Metal

/ With mounting material
/ Concealed fastening

/ Diameter of drilled hole: 0.23"

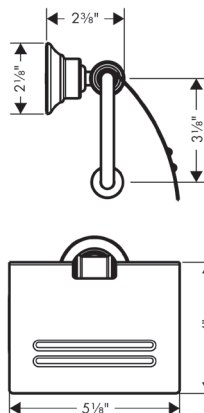

Certificates/declarations



Finish	Part No.	List \$
brushed gold optic	42036250	421
brushed black chrome	42036340	421
AXOR FinishPlus*	42036XX0	477

AXOR Montreux Toilet Brush with Holder, Wall-Mounted

Features

- / Wall-mounted
- / Metal, Porcelain
- / Material recess: Porcelain

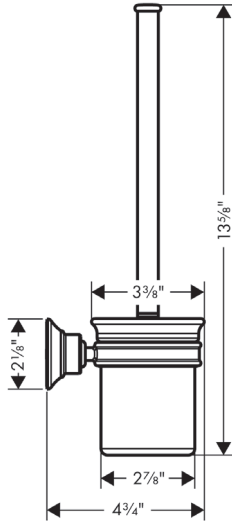

- / With removable insert
- / With mounting material
- / Concealed fastening

/ Diameter of drilled hole: 0.23"



Certificates/declarations



Finish	Part No.	List \$
 brushed gold optic	42035250	478
 brushed black chrome	42035340	478
 AXOR FinishPlus*	42035XX0	543

*For additional information please refer to the "special finish" overview.

AXOR New Products 2024 | Price Index

Brand	Part No.	List \$	Page
04			
AX	04998000	60	40
AX	04998250	79	40
AX	04998330	76	40
AX	04998340	79	40
AX	04998820	79	40
AX	04998830	76	40
AX	04998990	76	40
12			
AX	12571001	2,800	34
AX	12571251	3,696	34
AX	12571341	3,696	34
AX	12571671	3,696	34
AX	12571821	3,696	34
AX	12572001	3,300	34
AX	12572251	4,356	34
AX	12572341	4,356	34
AX	12572671	4,356	34
AX	12572821	4,356	34
AX	12573001	3,800	34
AX	12573251	5,016	34
AX	12573341	5,016	34
AX	12573671	5,016	34
AX	12573821	5,016	34
AX	12592001	1,900	30
AX	12592251	2,508	30
AX	12592341	2,508	30
AX	12592671	2,508	30
AX	12592821	2,508	30
AX	12593001	2,900	31
AX	12593251	3,828	31
AX	12593341	3,828	31
AX	12593671	3,828	31
AX	12593821	3,828	31
AX	12594001	3,700	31
AX	12594251	4,884	31
AX	12594341	4,884	31
AX	12594671	4,884	31
AX	12594821	4,884	31
AX	12595001	7,800	33
AX	12595251	10,296	33
AX	12595341	10,296	33
AX	12595671	10,296	33
AX	12595821	10,296	33
AX	12596001	750	36
AX	12596251	990	36
AX	12596341	990	36
AX	12596671	990	36
AX	12596821	990	36
AX	12597001	750	36
AX	12597251	990	36
AX	12597341	990	36
AX	12597671	990	36
AX	12597821	990	36
AX	12598001	750	36
AX	12598251	990	36

Brand	Part No.	List \$	Page
AX	12598341	990	36
AX	12598671	990	36
AX	12598821	990	36
AX	12676181	3,300	38
AX	12785001	7,800	33
AX	12785251	10,296	33
AX	12785341	10,296	33
AX	12785671	10,296	33
AX	12785821	10,296	33
AX	12791001	1,900	30
AX	12791251	2,508	30
AX	12791341	2,508	30
AX	12791671	2,508	30
AX	12791821	2,508	30
AX	12793001	2,900	31
AX	12793251	3,828	31
AX	12793341	3,828	31
AX	12793671	3,828	31
AX	12793821	3,828	31
AX	12796001	3,700	31
AX	12796251	4,884	31
AX	12796341	4,884	31
AX	12796671	4,884	31
AX	12796821	4,884	31
16			
AX	16911250	80	79
AX	16911340	135	79
18			
AX	18310181	1,497	39
AX	18311181	1,746	39
AX	18312181	1,900	39
28			
AX	28227000	100	38
AX	28227250	132	38
AX	28227330	127	38
AX	28227340	132	38
AX	28227670	132	38
AX	28227820	132	38
AX	28227830	127	38
AX	28227990	127	38
AX	28228000	100	39
AX	28228250	132	39
AX	28228330	127	39
AX	28228340	132	39
AX	28228670	132	39
AX	28228820	132	39
AX	28228830	127	39
AX	28228990	127	39
AX	28259000	125	38
AX	28259250	165	38
AX	28259330	159	38
AX	28259340	165	38
AX	28259670	165	38
AX	28259820	165	38
AX	28259830	159	38
AX	28259990	159	38

Brand	Part No.	List \$	Page
AX	28261000	125	39
AX	28261250	165	39
AX	28261330	159	39
AX	28261340	165	39
AX	28261670	165	39
AX	28261820	165	39
AX	28261830	159	39
AX	28261990	159	39
AX	28290000	150	38
AX	28290250	198	38
AX	28290330	191	38
AX	28290340	198	38
AX	28290670	198	38
AX	28290820	198	38
AX	28290830	191	38
AX	28290990	191	38
AX	28291000	150	39
AX	28291250	198	39
AX	28291330	191	39
AX	28291340	198	39
AX	28291670	198	39
AX	28291820	198	39
AX	28291830	191	39
AX	28291990	191	39
AX	28703001	350	37
AX	28703251	462	37
AX	28703341	462	37
AX	28703671	462	37
AX	28703821	462	37
AX	28704001	350	37
AX	28704251	462	37
AX	28704341	462	37
AX	28704671	462	37
AX	28704821	462	37
35			
AX	35358181	800	38
AX	35390181	334	38
36			
AX	36733001	325	41
AX	36733251	429	41
AX	36733341	429	41
AX	36733671	429	41
AX	36733821	429	41
AX	36734001	325	41
AX	36734251	429	41
AX	36734341	429	41
AX	36734671	429	41
AX	36734821	429	41
42			
AX	42000000	1,700	18
AX	42000250	2,244	18
AX	42000330	2,159	18
AX	42000340	2,244	18
AX	42000670	2,244	18
AX	42000820	2,244	18
AX	42000990	2,159	18

Brand	Part No.	List \$	Page
AX	42001000	1,900	18
AX	42001250	2,508	18
AX	42001330	2,413	18
AX	42001340	2,508	18
AX	42001670	2,508	18
AX	42001820	2,508	18
AX	42001990	2,413	18
AX	42002000	1,700	19
AX	42002250	2,244	19
AX	42002330	2,159	19
AX	42002340	2,244	19
AX	42002670	2,244	19
AX	42002820	2,244	19
AX	42002990	2,159	19
AX	42003000	2,000	19
AX	42003250	2,640	19
AX	42003330	2,540	19
AX	42003340	2,640	19
AX	42003670	2,640	19
AX	42003820	2,640	19
AX	42003990	2,540	19
AX	42004000	2,300	20
AX	42004250	3,036	20
AX	42004330	2,921	20
AX	42004340	3,036	20
AX	42004670	3,036	20
AX	42004820	3,036	20
AX	42004990	2,921	20
AX	42005000	11,000	21
AX	42005250	11,000	21
AX	42005330	11,000	21
AX	42005340	11,000	21
AX	42005670	11,000	21
AX	42005820	11,000	21
AX	42005990	11,000	21
AX	42006000	1,500	22
AX	42006250	1,500	22
AX	42006330	1,500	22
AX	42006340	1,500	22
AX	42006670	1,500	22
AX	42006820	1,500	22
AX	42006990	1,500	22
AX	42019250	478	74
AX	42019340	478	74
AX	42021250	385	75
AX	42021340	385	75
AX	42030250	478	76
AX	42030340	478	76
AX	42035250	478	77
AX	42035340	478	77
AX	42036250	421	76
AX	42036340	421	76
AX	42060250	497	76
AX	42060340	497	76
AX	42065250	458	74
AX	42065340	458	74

AXOR New Products 2024 | Price Index

Brand	Part No.	List \$	Page
AX	42090250	1,071	74
AX	42090340	1,071	74
AX	42137250	133	75
AX	42137340	133	75
AX	42436000	360	73
AX	42520001	750	24
AX	42520251	990	24
AX	42520341	990	24
AX	42520671	990	24
AX	42520701	990	24
AX	42520801	750	24
AX	42520821	990	24
AX	42521001	800	24
AX	42521251	1,056	24
AX	42521341	1,056	24
AX	42521671	1,056	24
AX	42521701	1,056	24
AX	42521801	800	24
AX	42521821	1,056	24
AX	42522001	850	25
AX	42522251	1,122	25
AX	42522341	1,122	25
AX	42522671	1,122	25
AX	42522701	1,122	25
AX	42522801	850	25
AX	42522821	1,122	25
AX	42523001	900	25
AX	42523251	1,188	25
AX	42523341	1,188	25
AX	42523671	1,188	25
AX	42523701	1,188	25
AX	42523801	900	25
AX	42523821	1,188	25
AX	42524001	950	25
AX	42524251	1,254	25
AX	42524341	1,254	25
AX	42524671	1,254	25
AX	42524701	1,254	25
AX	42524801	950	25
AX	42524821	1,254	25
AX	42525001	750	26
AX	42525251	990	26
AX	42525341	990	26
AX	42525671	990	26
AX	42525701	990	26
AX	42525801	750	26
AX	42525821	990	26
AX	42526001	800	26
AX	42526251	1,056	26
AX	42526341	1,056	26
AX	42526671	1,056	26
AX	42526701	1,056	26
AX	42526801	800	26
AX	42526821	1,056	26
AX	42527001	850	27
AX	42527251	1,122	27

Brand	Part No.	List \$	Page
AX	42527341	1,122	27
AX	42527671	1,122	27
AX	42527701	1,122	27
AX	42527801	850	27
AX	42527821	1,122	27
AX	42528001	900	27
AX	42528251	1,188	27
AX	42528341	1,188	27
AX	42528671	1,188	27
AX	42528701	1,188	27
AX	42528801	900	27
AX	42528821	1,188	27
AX	42529001	950	27
AX	42529251	1,254	27
AX	42529341	1,254	27
AX	42529671	1,254	27
AX	42529701	1,254	27
AX	42529801	950	27
AX	42529821	1,254	27
AX	42604670	609	67
AX	42605670	487	67
AX	42610670	669	67
AX	42611670	168	71
AX	42613670	730	71
AX	42622670	882	68
AX	42623670	548	69
AX	42626670	578	68
AX	42639670	639	68
AX	42644670	1,064	69
AX	42649670	942	69
AX	42654670	441	72
AX	42655670	730	72
AX	42656670	441	71
AX	42657670	578	71
AX	42661670	851	71
AX	42683670	873	71
AX	42804700	360	60
AX	42805700	312	60
AX	42810700	407	60
AX	42811700	63	60
AX	42812700	173	60
AX	42813700	437	63
AX	42822700	594	63
AX	42823700	360	62
AX	42826700	312	63
AX	42843700	812	64
AX	42844700	578	61
AX	42848700	1,093	61
AX	42849700	844	61
AX	42855700	499	66
AX	42856700	219	65
AX	42857700	328	65
AX	42858700	437	65
AX	42860700	375	64
AX	42872700	469	66
AX	42873700	250	66

Brand	Part No.	List \$	Page
AX	42880700	499	64
45			
AX	45711701	1,914	47
AX	45712701	2,082	47
AX	45713701	2,290	47
AX	45723701	347	51
AX	45772701	559	48
47			
AX	47010671	1,507	54
AX	47012671	1,280	54
AX	47020671	1,961	54
AX	47022671	1,667	54
AX	47050671	2,533	55
AX	47052671	2,153	55
AX	47060671	1,280	56
AX	47062671	1,090	56
AX	47430671	4,221	57
AX	47432671	3,589	57
AX	47440671	4,297	56
AX	47442671	3,652	56
AX	47903670	253	58
AX	47904670	329	58
48			
AX	48001701	1,093	45
AX	48002701	1,406	45
AX	48020701	1,406	44
AX	48030701	1,827	44
AX	48050701	1,827	45
AX	48060701	1,686	44
AX	48070701	2,030	46
AX	48112701	1,498	46
AX	48441701	5,619	52
AX	48481701	2,519	48
AX	48482701	2,519	48
AX	48483701	2,204	49
AX	48484701	2,204	49
AX	48485701	523	51
AX	48489701	435	51
AX	48497701	435	51
AX	48498701	435	51
AX	48652701	245	51
AX	48653701	245	51
AX	48654701	245	51
AX	48791701	762	52
AX	48793701	762	52

Hansgrohe, Inc. Limited Warranty

Offering our customers the highest quality at all times is a fundamental part of the Hansgrohe, Inc. company philosophy. We offer consumers a limited warranty on our hansgrohe® and AXOR® branded products.

This warranty is limited to products manufactured by Hansgrohe, Inc. that are purchased from a Hansgrohe, Inc. authorized seller by a consumer in the United States or Canada after September 1, 2019, and installed in either the United States or in Canada.

WARRANTY

Hansgrohe, Inc. warrants to the original consumer purchaser that hansgrohe and AXOR products will be free from defects in material and workmanship for as long as the original consumer purchaser owns both the product and the home in which the product was originally installed. For commercial purchasers, the warranty period is (a) one (1) year for hansgrohe products and (b) five (5) years for AXOR products, in each case from the date of purchase. The warranty period for products in the Rubbed Bronze, Brushed Gold Optic, Brushed Black Chrome, Matte Black, and Matte White finishes are three (3) years from the date of purchase. This warranty is non-transferable.

WHAT WE WILL DO

Hansgrohe, Inc., at its option, will replace any product or part of the product that proves defective in workmanship and/ or material, under normal installation, use, service and maintenance. If Hansgrohe, Inc. is unable to provide a replacement part or product and repair is not practical or cannot be made in timely fashion, Hansgrohe, Inc. may elect to refund the purchase price in exchange for the return of the defective product. REPAIR OR REPLACEMENT (OR, IN LIMITED CIRCUMSTANCES, REFUND OF THE PURCHASE PRICE) AS PROVIDED UNDER THIS LIMITED WARRANTY IS THE EXCLUSIVE REMEDY OF THE PURCHASER.

WHAT IS NOT COVERED BY THE WARRANTY

Because Hansgrohe, Inc. is unable to control the quality of hansgrohe or AXOR products sold by unauthorized sellers, unless otherwise prohibited by law, this warranty does not cover hansgrohe or AXOR products purchased from unauthorized sellers. Authorized sellers can be found on hansgrohe and AXOR branded websites.

Labor and other expenses for disconnection, deinstallation, or return of the product for warranty service (including but not limited to proper packaging and shipping costs), or for installation or reinstallation of the product are not covered by this warranty. Hansgrohe, Inc. shall not be liable for any damage to the product resulting from reasonable wear and tear, outdoor use, misuse (including use of the product for an unintended application), freezing water, excessive water pressure, pipe corrosion in the home in which the product is installed, abuse, neglect or improper or incorrectly performed installation, maintenance or repair, including the use of abrasive or caustic cleaning agents or "no-rinse" cleaning products.

This warranty does not cover: (i) accessories, connected materials and products, or related products not manufactured by Hansgrohe, Inc. (ii) any hansgrohe or AXOR product sold for display purposes or (iii) hansgrohe or AXOR products purchased from unauthorized sellers.

WHAT YOU MUST DO TO OBTAIN WARRANTY SERVICE OR INFORMATION

Contact your retailer, or contact Technical Service at:

Hansgrohe, Inc.
1492 Bluegrass Lakes Parkway
Alpharetta, GA 30004
Toll-free 800-334-0455

In requesting warranty service, you will need to provide:

1. The sales receipt or other evidence of the date and place of purchase.
2. A description of the problem.
3. Delivery of the product or the defective part, postage prepaid and carefully packed and insured, to: Hansgrohe, Inc. 1492 Bluegrass Lakes Parkway Alpharetta, GA 30004 Toll-free 800-334-0455

When warranty service is completed, any repaired or replacement product or part will be returned to you postage prepaid. REVISED SEPTEMBER 1, 2019. Limitation on Duration of Implied Warranties. Some States do not allow limitations on how long an implied warranty lasts, so the below limitations may not apply to you. TO THE MAXIMUM EXTENT PERMITTED BY APPLICABLE LAW, ANY IMPLIED WARRANTY, INCLUDING THE IMPLIED WARRANTIES OF MERCHANTABILITY AND OF FITNESS FOR A PARTICULAR PURPOSE, IS LIMITED TO THE STATUTORY PERIOD OR THE DURATION OF THIS WARRANTY, WHICHEVER IS SHORTER.

Limitation of Special, Incidental or Consequential Damages. Some States do not allow the exclusion or limitation of incidental or consequential damages, so the below limitations and exclusions may not apply to you. TO THE MAXIMUM EXTENT PERMITTED BY APPLICABLE LAW, THIS WARRANTY DOES NOT COVER, AND HANSGROHE, INC. SHALL NOT BE LIABLE FOR, ANY SPECIAL, INCIDENTAL OR CONSEQUENTIAL DAMAGES (INCLUDING LABOR CHARGES TO REPAIR, REPLACE, INSTALL OR REMOVE THIS PRODUCT), WHETHER ARISING OUT OF BREACH OF ANY EXPRESS OR IMPLIED WARRANTY, BREACH OF CONTRACT, TORT, OR OTHERWISE. HANSGROHE, INC. SHALL NOT BE LIABLE FOR ANY DAMAGE TO THE PRODUCT RESULTING FROM REASONABLE WEAR AND TEAR, OUTDOOR USE, MISUSE (INCLUDING USE OF THE PRODUCT FOR AN UNINTENDED APPLICATION), FREEZING WATER, EXCESSIVE WATER PRESSURE, PIPE CORROSION IN THE HOME IN WHICH THE PRODUCT IS INSTALLED, ABUSE, NEGLIGENCE OR IMPROPER OR INCORRECTLY PERFORMED INSTALLATION, MAINTENANCE OR REPAIR, INCLUDING THE USE OF ABRASIVE OR

Additional Information

CAUSTIC CLEANING AGENTS OR "NO-RINSE" CLEANING PRODUCTS. Notice to residents of the State of New Jersey: The provisions of this warranty, including its limitations, are intended to apply to the fullest extent permitted by the laws of the State of New Jersey.

This warranty gives you specific legal rights, and you may also have other rights which vary from state to state.

PRODUCT INSTRUCTIONS AND QUESTIONS

Upon purchase or prior to installation, please carefully inspect your product for any damage or visible defect. Prior to installing, always carefully study the enclosed instructions on the proper installation and the care and maintenance of this product. If you have questions at any time about the use, installation or performance of your product, or the Limited Warranty, please write us or call us toll-free at 800-334-0455.

HANSGROHE, INC. RETURN GOODS POLICY

Hansgrohe, Inc. is dedicated to customer satisfaction. If for any reason you must return a product to us, please follow our Return Policy. Product should not be returned for credit or replacement without prior written authorization from Hansgrohe, Inc. Any product returned and received by Hansgrohe, Inc. without prior written authorization will not be accepted. You will be notified and the items will be returned at your expense.

- To return any hansgrohe or AXOR brand products you must first obtain a Return Goods Authorization (RGA) number from us. Fax (770-889-1783), phone (800-334-0455) or e-mail (customerservice@hansgrohe.com) your request to Hansgrohe, Inc. listing the invoice number or purchase order number, part number(s), quantity and the reason for the return. An RGA number and a copy of the list of items approved for return will be faxed to you.
- Return Goods Authorization will expire 60 days after the date of issue.
- Returned hansgrohe or AXOR brand products will incur a 25% (\$20 minimum) restocking charge, unless the return is due to an error by Hansgrohe, Inc. or if there is a product defect.
- All items must be returned in their original product box. Showerpanels and shower columns will incur a \$40 per item rebox charge. All other damaged or otherwise unusable boxes will incur a \$10 per item rebox charge. All hansgrohe and AXOR brand product boxes must be placed in outer shipping carton(s) with adequate packing material to ensure that the product is not damaged while in transit. Please include a copy of the faxed RGA in your shipment. The RGA number must be clearly written on the outside of the shipping carton(s) and also be referenced on the shipping label(s).
- Hansgrohe, Inc. will not accept returns on phase-out product after five months from the date of the announcement from Hansgrohe, Inc. Any returns of such product during this five month period will incur a 25% restocking fee.
- Hansgrohe, Inc. will not accept returns on discontinued product that is not listed in the current price book.
- Custom products are non-returnable and cannot be cancelled upon receipt of order confirmation sent from Hansgrohe, Inc.

The return shipment should be sent freight prepaid to:

Hansgrohe, Inc.
Attn: RGA Department
1492 Bluegrass Lakes Parkway
Alpharetta, GA 30004

- Receipt of returned product does not guarantee credit. The value of the returned goods will be determined following inspection of the items received. Credit will only be issued for those items that meet Hansgrohe, Inc.'s Return Goods Policy conditions.

Warranty and Terms

Hansgrohe General Terms and Conditions Overview

Prices:	All prices are subject to change without notice and are exclusive of any shipping, delivery or handling charges that may apply.
Terms:	2% 10 days; net 30 days
Minimum Order:	Our minimum invoice is \$50 net. Any orders totaling less than \$50 net will be billed at \$50 net.
Freight:	All orders are shipped by the method and carrier of Hansgrohe, Inc.'s choosing. If special routing or expedition is requested, we reserve the right to invoice any additional costs incurred. Full freight is allowed on shipments of \$2,500 net, invoice value, for ground shipments within the contiguous United States. All other shipments of lesser value will be shipped F.O.B. Alpharetta, Georgia. Oversized packages will be charged carrier's published price plus handling.
Damage or Loss:	Our responsibility ends at the time Hansgrohe delivers merchandise in original condition to the carrier. Delivery to the carrier constitutes delivery to the customer. All claims for damaged or lost shipments should be
Scope and Place of Delivery, Transport and Transfer of Risk:	made promptly by the customer to the carrier. Hansgrohe will procure that the products shipped by Hansgrohe to the buyer comply with the laws and regulations of the country / countries designated by the buyer. In case the buyer - after receipt of the products - exports the products to third countries it is the obligation of the buyer to make sure that the products comply with the applicable local laws and regulations of such countries with regard to the products. If, however, the buyer chooses to export products to third countries, the buyer is solely responsible for any and all liability resulting from any non-compliance of the products.
Claims:	All claims must be made within seven (7) days of receipt of merchandise.
Returns:	See Previous Page.
Drop Shipments:	Residential drop shipments will incur a higher cost via discount multiplier.

All allowances, rebates, incentives or other amounts we offer you from time to time (collectively "Programs") are earned and payable only if your accounts (including those of your subsidiaries and affiliates) are current with all Masco Corporation subsidiaries and affiliates. In addition, Programs are not earned or payable if the ratings issued by any agency, such as S&P, Moody's, or Fitch, relating to your company, parent, subsidiaries, or affiliates are lower than investment grade quality. Any earned payment may be withheld or be used to satisfy any of the accounts or other obligations to a Masco subsidiary or affiliate.

THESE TERMS OF SALE ARE SUBJECT TO CHANGE. PRIOR TO PLACING AN ORDER WITH HANSGROHE, INC. PLEASE GO TO WWW.HANSGROHE-USA.COM, OR CONTACT ONE OF OUR REPRESENTATIVES AT 800-334-0455 TO OBTAIN HANSGROHE, INC.'S THEN CURRENT TERMS OF SALE.

HANSGROHE AND AXOR BRAND PRODUCTS MAY BE DISCONTINUED AT ANY TIME WITHOUT NOTICE. PRODUCTS LISTED AS "PHASE OUT" WILL ONLY BE AVAILABLE WHILE SUPPLIES LAST. PLEASE CALL TO CONFIRM AVAILABILITY.

See following pages for detailed general terms and conditions.

GENERAL TERMS AND CONDITIONS FOR THE SALE OF GOODS

! . Applicability.

(a) These terms and conditions of sale (these “**Terms**”) are the only terms which govern the sale of the goods (“**Goods**”) by Hansgrohe, Inc. (“**Seller**”) to the buyer named in the Sales Confirmation (as defined below) (“**Buyer**”). Notwithstanding anything herein to the contrary, if a written contract signed by both parties is in existence covering the sale of the Goods covered hereby, the terms and conditions of said contract shall prevail to the extent they are inconsistent with these Terms.

(b) The quotation or confirmation of sale (the “**Sales Confirmation**”) and these Terms (collectively, this “**Agreement**”) comprise the entire agreement between the parties, and supersede all prior or contemporaneous understandings, agreements, negotiations, representations and warranties, and communications, both written and oral with respect to the subject matter hereof. These Terms prevail over any of Buyer’s general terms and conditions of purchase regardless of whether or when Buyer has submitted its purchase order or such terms, all of which are hereby rejected. Fulfillment of Buyer’s order does not constitute acceptance of any of Buyer’s terms and conditions and does not serve to modify or amend these Terms.

(c) Unless otherwise agreed in writing, Buyer will be deemed to have waived any objection to these Terms if Seller has not received written Notice of such objection within ten (10) days of the date of Buyer’s order. In any event, Buyer will be deemed to have agreed to these Terms if Buyer accepts any portion of the Goods. Buyer acknowledges that the prices quoted by Buyer are predicated on the enforceability of these Terms, that the price of the Goods would be substantially higher if these Terms did not apply, and that Buyer accepts these Terms in exchange for such lower prices.

#. Forecasts. From time-to-time, Buyer may, but shall not be required to, provide Seller with Forecasts. Any Forecasts are for information purposes only and do not create any binding obligations on behalf of either Party. Neither Seller’s nor Buyer’s failure to comply with any Forecast is a breach of this Agreement. For the purposes of this Agreement, “**Forecast**” means, with respect to any time period, a good faith forecast of Buyer’s demand for each calendar month during the period, broken down by individual Goods, which approximates, as nearly as possible, based on information available at the time to Buyer, the Purchase Orders subsequently to be placed by Buyer for each such calendar month.

\$. Delivery of Goods.

(a) Unless otherwise agreed to in writing between the parties, the Goods will be delivered within a reasonable time after the receipt of Buyer’s purchase order, subject to availability of finished Goods. Seller shall not be liable for any delays, loss or damage in transit.

(b) Notwithstanding Section #(a) hereof, if under this Agreement Buyer submits blanket purchase orders for Goods to Seller, Buyer shall issue any releases under such purchase order, with each such release including a definite quantity of Goods, no later than \$ months before Buyer’s preferred date of delivery. If Buyer issues any such release less than \$ months before Buyer’s preferred date of delivery, Seller will use reasonable efforts to meet such preferred date of delivery and quantity of Goods but Seller shall not be liable for any delays or delivering less than the quantity specified in such release.

(c) Unless otherwise agreed in writing by the parties, Seller shall deliver the Goods F.O.B. Alpharetta, Georgia, at which time title and all risk of loss will pass to Buyer.

(d) Unless Seller otherwise agrees in writing, shipments will be by a carrier and by the route selected by Seller. The carrier will act as Buyer’s agent and delivery by Seller to such carrier will constitute delivery to Buyer. Buyer will pay all freight charges and assume the risks of transportation, including delay, damage and loss, unless Seller otherwise agrees in writing. Seller may, in its sole discretion, without liability or penalty, make partial shipments of Goods to Buyer. Each shipment will constitute a separate sale, and Buyer shall pay for the units shipped whether such shipment is in whole or partial fulfillment of Buyer’s purchase order.

& . Non-Delivery.

(a) The quantity of any installment of Goods as recorded by Seller on dispatch from Seller’s place of business is conclusive evidence of the quantity received by Buyer on delivery unless Buyer can provide conclusive evidence proving the contrary.

(b) Seller shall not be liable for any non-delivery of Goods (even if caused by Seller’s negligence) unless Buyer gives written notice to Seller of the non-delivery within 10 days of the date when the Goods would in the ordinary course of events have been received.

(c) Any liability of Seller for non-delivery of the Goods shall be limited to replacing the Goods within a reasonable time or adjusting the invoice respecting such Goods to reflect the actual quantity delivered.

(d) Except as provided under Section \$(c), all sales of Goods to Buyer are made on a one-way basis and Buyer has no right to return Goods purchased under this Agreement to Seller.

(. Security Interest.

As collateral security for the payment of the purchase price of the Goods and performance in full of all the obligations of the Buyer under this Agreement, the Buyer hereby pledges and grants to the Seller, a lien on and security interest in and to all of the right, title, and interest of the Buyer in, to, and under the Goods, wherever located, and whether now existing or hereafter arising or acquired from time to time, and in all accessions thereto and replacements or modifications thereof, as well as all proceeds (including insurance proceeds) of the foregoing. The security interest granted under this provision constitutes a purchase-money security interest under Article 9 of the Georgia Uniform Commercial Code and Buyer grants to Seller power of attorney to file and cause all documents and actions to file and perfect any security interest, including but not limited to any UCC-1 filing.

* . Buyer’s Acts or Omissions.

If Seller’s performance of its obligations under this Agreement is prevented or delayed by any act or omission of Buyer or its agents, subcontractors, consultants or employees, Seller shall not be deemed in breach of its obligations under this Agreement or otherwise liable for any costs, charges or losses sustained or incurred by Buyer, in each case, to the extent arising directly or indirectly from such prevention or delay.

! . Inspection and Rejection of Nonconforming Goods.

(a) Buyer shall inspect the Goods within 10 days of receipt (“**Inspection Period**”). Buyer will be deemed to have accepted the Goods unless it notifies Seller in writing of any Nonconforming Goods during the Inspection Period and furnishes such written evidence or other documentation as required by Seller. “**Nonconforming Goods**” means only the following: (i) product shipped is different than identified in Buyer’s purchase order; or (ii) product’s label

GENERAL TERMS AND CONDITIONS FOR THE SALE OF GOODS

or packaging incorrectly identifies its contents.

(b) If Buyer timely notifies Seller of any Nonconforming Goods, Seller shall, in its sole discretion, (i) replace such Nonconforming Goods with conforming Goods, or (ii) credit or refund the Price for such Nonconforming Goods, together with any reasonable shipping and handling expenses incurred by Buyer in connection therewith. Buyer shall ship, at its expense and risk of loss, the Nonconforming Goods to Seller's facility located at 1 " # \$ Bluegrass Lakes Parkway, Alpharetta, GA % \$ \$ \$ ". If Seller exercises its option to replace Nonconforming Goods, Seller shall, after receiving Buyer's shipment of Nonconforming Goods, ship to Buyer, at Buyer's expense and risk of loss, the replaced Goods F.O.B Alpharetta, Georgia.

(c) Buyer acknowledges and agrees that the remedies set forth in **Section 6(b)** are Buyer's exclusive remedies for the delivery of Nonconforming Goods. Except as provided under **Section 6(b)**, all sales of Goods to Buyer are made on a one-way basis and Buyer has no right to return Goods purchased under this Agreement to Seller. Notwithstanding the foregoing, if Seller, at its sole discretion, authorizes Buyer to return some or all of the conforming Goods Seller may charge to Buyer a restocking fee of &' % of the net value of any returned Goods, with a minimum fee of \$ & \$ ("Restocking Fee"), and Seller may deduct such Restocking Fee from any credit or refund of the Price, if any. All Goods must be returned in their original product box. Shower panels and shower columns will incur a \$ " \$ per item rebox charge. All other damaged or otherwise unusable boxes will incur a \$! \$ per Good rebox charge.

I . Price.

(a) Buyer shall purchase the Goods from Seller at the prices (the "**Prices**") set forth in Seller's published price list in force as of the date that Seller accepts Buyer's purchase order. If the Prices should be increased by Seller before delivery of the Goods to a carrier for shipment to Buyer, then these Terms shall be construed as if the increased prices were originally inserted herein, and Buyer shall be billed by Seller on the basis of such increased prices.

(b) All Prices are exclusive of all sales, use and excise taxes, and any other similar taxes, duties and charges of any kind imposed by any Governmental Authority on any amounts payable by Buyer. Buyer shall be responsible for all such charges, costs and taxes; provided, that, Buyer shall not be responsible for any taxes imposed on, or with respect to, Seller's income, revenues, gross receipts, personnel or real or personal property or other assets.

. Payment Terms.

(a) Buyer shall pay all invoiced amounts due to Seller on receipt of Seller's invoice. Buyer shall make all payments hereunder in US dollars by wire transfer, check or as otherwise specified in Seller's invoice sent to Buyer.

(b) Buyer shall pay interest on all late payments at the higher of the rate of ! ' % per month or the highest rate permissible under applicable law. Buyer shall reimburse Seller for all costs incurred in collecting any late payments, including, without limitation, attorneys' fees. In addition to all other remedies available under these Terms or at law (which Seller does not waive by the exercise of any rights hereunder), Seller shall be entitled to suspend the delivery of any Goods if Buyer fails to pay any amounts when due hereunder and such failure continues for ' days following written notice thereof.

(c) Buyer shall not withhold payment of any amounts due and payable by reason of any set-o) of any claim or dispute with Seller, whether relating to Seller's breach, bankruptcy or otherwise.

! \$. Limited Warranty.

(a) Seller extends express, written warranties on the Goods in accordance with the terms, conditions and limitations of the applicable warranty ("Warranty") set forth on Seller's Web Site (www.hansgrohe-usa.com or such other address as may be identified on the Product Documents) and/or the applicable product packages, labels and instruction sheets ("Product Documents"). Fulfillment of the Warranty obligations to the purchasers of Seller's products (or their permissible transferees) is Seller's warranty obligation for the Goods.

(b) EXCEPT AS EXPRESSLY PROVIDED IN SELLER'S WARRANTY (AS DEFINED IN SECTION 10(A)), SELLER MAKES NO WARRANTY WHATSOEVER WITH RESPECT TO THE GOODS, INCLUDING ANY (a) WARRANTY OF MERCHANTABILITY; OR (b) WARRANTY OF FITNESS FOR A PARTICULAR PURPOSE; WHETHER EXPRESS OR IMPLIED BY LAW, COURSE OF DEALING, COURSE OF PERFORMANCE, USAGE OF TRADE OR OTHERWISE.

(c) Products manufactured by a third party ("Third Party Product") may constitute, contain, be contained in, incorporated into, attached to or packaged together with, the Goods. SELLER MAKES NO REPRESENTATIONS OR WARRANTIES WITH RESPECT TO ANY THIRD PARTY PRODUCT, INCLUDING ANY (a) WARRANTY OF MERCHANTABILITY; (b) WARRANTY OF FITNESS FOR A PARTICULAR PURPOSE; OR (c) WARRANTY AGAINST INFRINGEMENT OF INTELLECTUAL PROPERTY RIGHTS OF A THIRD PARTY; WHETHER EXPRESS OR IMPLIED BY LAW, COURSE OF DEALING, COURSE OF PERFORMANCE, USAGE OF TRADE OR OTHERWISE.

(d) The Seller shall not be liable for a breach of its obligations under this Agreement or based on any other theory of liability unless: (i) Buyer gives written notice of the defective Goods, reasonably described, to Seller within * days of the time when Buyer discovers or ought to have discovered the defect; (ii) if applicable, Seller is given a reasonable opportunity after receiving the notice of breach to examine such Goods and Buyer (if requested to do so by Seller) returns such Goods to Seller's place of business at Seller's cost for the examination to take place there; and (iii) Seller reasonably verifies Buyer's claim that the Goods are defective.

(e) The Seller shall not be liable for a breach of its obligations under this Agreement or based on any other theory of liability if: (i) Buyer makes any further use of such Goods after giving such notice; (ii) the defect arises because Buyer failed to follow Seller's oral or written instructions as to the storage, installation, commissioning, use or maintenance of the Goods; or (iii) Buyer alters or repairs such Goods without the prior written consent of Seller.

(f) Buyer agrees that all claims arising under this Agreement will only be valid for one (!) year from the date of purchase. Subject to **Section 10(d)** and **Section 10(e)** above, with respect to any claims made by Buyer during such one (!) year period, Seller shall, in its sole discretion, either: (i) repair or replace such Goods (or the defective part) or (ii) issue a credit for such Goods in accordance with this Agreement and the Warranty, provided that, if Seller so requests, Buyer shall, at Seller's expense, return such Goods to Seller.

(g) THE REMEDIES SET FORTH IN SECTION 10(f) SHALL BE THE BUYER'S SOLE AND EXCLUSIVE REMEDY AND SELLER'S ENTIRE LIABILITY FOR ANY BREACH OF THE SELLER'S OBLIGATIONS UNDER THIS AGREEMENT.

!! . Limitation of Liability.

(a) IN NO EVENT SHALL SELLER BE LIABLE TO BUYER OR ANY THIRD PARTY FOR ANY LOSS OF USE, REVENUE OR PROFIT OR LOSS OF DATA OR DIMINUTION IN VALUE, OR FOR ANY CONSEQUENTIAL, INDIRECT, INCIDENTAL, SPECIAL, EXEMPLARY, OR PUNITIVE DAMAGES WHETHER ARISING OUT OF BREACH OF CONTRACT, TORT (INCLUDING NEGLIGENCE) OR OTHERWISE, REGARDLESS OF WHETHER SUCH DAMAGES WERE FORESEEABLE AND WHETHER OR NOT SELLER HAS BEEN ADVISED OF THE POSSIBILITY OF SUCH

GENERAL TERMS AND CONDITIONS FOR THE SALE OF GOODS

DAMAGES. BUYER'S RIGHT TO RECOVER DAMAGES WITHIN THE LIMITATIONS SPECIFIED IN SECTION 11 (b) IS BUYER'S EXCLUSIVE ALTERNATIVE REMEDY IN THE EVENT THAT THE REMEDY IN SECTION 10(f) FAILS OF ITS ESSENTIAL PURPOSE.

(b) SELLER'S MAXIMUM AGGREGATE LIABILITY, IF ANY, FOR ALL DAMAGES ARISING OUT OF OR RELATED TO THIS AGREEMENT, WHETHER ARISING OUT OF OR RELATED TO BREACH OF CONTRACT, TORT (INCLUDING NEGLIGENCE) OR OTHERWISE, IS LIMITED TO AN AMOUNT NOT TO EXCEED THE THEN-CURRENT WHOLESALE PRICE OF THE GOODS SOLD HEREUNDER.

!# . Compliance with Law. In the event that Buyer ships the Goods to, or sells the Goods in, a state or country other than the state specified in the purchase order, it is the obligation of the Buyer to make sure that the Goods comply with the applicable laws and regulations of such states or countries with regard to the Goods. In the event that Buyer ships the Goods to a distribution center, it is the obligation of the Buyer to make sure that the Goods comply with the applicable laws and regulations of each state or country in which the Goods are sold.

!\$. Termination. In addition to any remedies that may be provided under these Terms, Seller may terminate this Agreement with immediate effect upon written notice to Buyer, if Buyer: (a) fails to pay any amount when due under this Agreement; (b) has not otherwise performed or complied with any of these Terms, in whole or in part; or (c) becomes insolvent, files a petition for bankruptcy or commences or has commenced against it proceedings relating to bankruptcy, receivership, reorganization or assignment for the benefit of creditors. In addition, Seller may terminate this Agreement if any governmental authority imposes antidumping or countervailing duties or any other penalties on Goods.

!%. Waiver. No waiver by Seller of any of the provisions of this Agreement is effective unless explicitly set forth in writing and signed by Seller. No failure to exercise, or delay in exercising, any right, remedy, power or privilege arising from this Agreement operates, or may be construed, as a waiver thereof. No single or partial exercise of any right, remedy, power or privilege hereunder precludes any other or further exercise thereof or the exercise of any other right, remedy, power or privilege.

!&. Confidential Information. All non-public, confidential or proprietary information of Seller, including but not limited to, specifications, samples, patterns, designs, plans, drawings, documents, data, business operations, customer lists, pricing, discounts or rebates, disclosed by Seller to Buyer, whether disclosed orally or disclosed or accessed in written, electronic or other form or media, and whether or not marked, designated or otherwise identified as "confidential" in connection with this Agreement is confidential, solely for the use of performing this Agreement and may not be disclosed or copied unless authorized in advance by Seller in writing. Upon Seller's request, Buyer shall promptly return all documents and other materials received from Seller. Seller shall be entitled to injunctive relief for any violation of this Section. This Section does not apply to information that is: (a) in the public domain; (b) known to Buyer at the time of disclosure; or (c) rightfully obtained by Buyer on a non-confidential basis from a third party.

!' . Force Majeure. The Seller shall not be liable or responsible to Buyer, nor be deemed to have defaulted or breached this Agreement, for any failure or delay in fulfilling or performing any term of this Agreement when and to the extent such failure or delay is caused by or results from acts or circumstances beyond the reasonable control of Seller including, without limitation, as to Seller and its facilities and products and the facilities, materials and products of its suppliers, acts of God, flood, fire, earthquake, explosion, orders, directions or actions of any public authority, war, invasion or hostilities (whether war is declared or not), terrorist threats or acts, riot, or other civil unrest, national emergency, revolution, insurrection, epidemic, pandemic, lockouts, labor shortages, strikes or other labor disputes (whether or not relating to either party's workforce), restraints or delays affecting carriers, inability or delay in obtaining supplies of adequate or suitable materials, components or services, telecommunication breakdown or power outage, shortage or failure (all such circumstances collectively, "**Force Majeure Events**"). Seller may terminate this Agreement with immediate effect in case of any Force Majeure Event, which continues for & days or more. During any such delay or failure to perform by Seller, Seller's obligations under these Terms shall be suspended and Seller will not have any obligation to provide Buyer with the products or goods from other sources or to pay or reimburse Buyer for any additional costs to Buyer of obtaining substitute products or goods. Seller may, during any period of shortage due to any of the above circumstances, allocate its available supply of products or goods among its customers in any manner that it deems fair and reasonable in its sole discretion.

!| . Assignment. Buyer shall not assign any of its rights or delegate any of its obligations under this Agreement without the prior written consent of Seller. Any purported assignment or delegation in violation of this Section is null and void. No assignment or delegation relieves Buyer of any of its obligations under this Agreement.

!} . Relationship of the Parties. The relationship between the parties is that of independent contractors. Nothing contained in this Agreement shall be construed as creating any agency, partnership, joint venture or other form of joint enterprise, employment or fiduciary relationship between the parties, and neither party shall have authority to contract for or bind the other party in any manner whatsoever.

!* . No Third-Party Beneficiaries. This Agreement is for the sole benefit of the parties hereto and their respective successors and permitted assigns and nothing herein, express or implied, is intended to or shall confer upon any other person or entity any legal or equitable right, benefit or remedy of any nature whatsoever under or by reason of these Terms.

"# . Governing Law. All matters arising out of or relating to this Agreement are governed by and construed in accordance with the internal laws of the State of Georgia without giving effect to any choice or conflict of law provision or rule (whether of the State of Georgia or any other jurisdiction) that would cause the application of the laws of any jurisdiction other than those of the State of Georgia. The United Nations Convention on Contracts for the International Sale of Goods (CISG) shall not apply to this Agreement.

"! . Arbitration. The Parties agree that any dispute, claim, or controversy arising out of, connected with, or related to this Agreement ("**Dispute**"), or the dealings between the Parties occurring at any time (including before the inception of or after termination of this Agreement), including without limitation any Dispute arising out of, connected with, or related to (i) the creation, existence, scope, validity, effect, interpretation, performance or non-performance, or termination of, or the legal relationships established by, this Agreement, or the consequences of its supposed nullity; (ii) any non-contractual rights or obligations arising out of, connected with, or related to this Agreement; and (iii) the relationship between the Parties created by this Agreement and any dealings between the Parties related to the subject matter of the transactions contemplated by this Agreement; all regardless of whether such Dispute may be characterized as sounding in contract, tort, breach of duty, fraud (including fraudulent inducement to enter into or fraud in the inception of this Agreement), or any other common law or statutory law or equitable principle or doctrine and regardless of the relief sought (even if such relief includes rescission of this Agreement) shall be finally and conclusively resolved by binding arbitration. Such arbitration will be conducted by one arbitrator in the English language in the city of Atlanta, Georgia, under the administration of the American Arbitration Association ("**AAA**") in accordance with the laws of the State of Georgia and the AAA's Commercial Arbitration Rules and Mediation Procedures (collectively, the "**Rules**"). The Parties to the arbitration shall facilitate the arbitration by: (i) conducting arbitration hearings to the greatest extent possible on successive days; and (ii) observing strictly the periods established by the Rules or by the arbitrator for the submission of evidence or briefs. Any award rendered by the arbitrator shall be final and binding upon each Party to the arbitration and judgment on the award may be entered in any court of competent jurisdiction. The arbitration award may be enforced by any court of competent jurisdiction through injunctive or other equitable relief, as well as all relief and process available at law. The arbitrator may issue interim awards, interlocutory, provisional or partial relief, including temporary restraining orders, preliminary injunctions, orders to compel discovery, orders of attachment,

GENERAL TERMS AND CONDITIONS FOR THE SALE OF GOODS

protective orders, any of which may be enforced as an arbitration award by any court of competent jurisdiction. Any arbitration award for money shall be made and shall be payable in U.S. dollars. The arbitrator may award interest from the date of any breach of this Agreement and shall fix the rate of interest on any amount awarded from the date of the award to the date the award is paid in full.

!! . Submission to Jurisdiction for Enforcement. For purposes of an action to confirm or enforce any award entered in the arbitration, the Parties hereby submit to personal jurisdiction in the Fulton County Superior Court, State of Georgia, or the United States District Court for the Northern District of Georgia. In addition, for purposes of an action to enforce any award entered in the arbitration, Buyer hereby submits to personal jurisdiction in any court anywhere in the world having jurisdiction over property that is the subject of this Agreement or Buyer's a" airs, other property, or assets (including money and deposit accounts) in respect of or against which such award may be enforced, regardless of whether such a" airs, property, or assets have any relation to the subject matter of this Agreement and even if Buyer's contacts with the forum for enforcement are fleeting, incidental, or unintentional.

!# . Notices. All notices, requests, consents, claims, demands, waivers and other communications hereunder (each, a "**Notice**") shall be in writing and addressed to the parties at the addresses set forth on the face of the Sales Confirmation or to such other address that may be designated by the receiving party in writing. All Notices shall be delivered by personal delivery, nationally recognized overnight courier (with all fees pre-paid), facsimile (with confirmation of transmission) or certified or registered mail (in each case, return receipt requested, postage prepaid). Except as otherwise provided in this Agreement, a Notice is e" ective only (a) upon receipt of the receiving party, and (b) if the party giving the Notice has complied with the requirements of this Section.

!\$. Severability. If any term or provision of this Agreement is invalid, illegal or unenforceable in any jurisdiction, such invalidity, illegality or unenforceability shall not a" ect any other term or provision of this Agreement or invalidate or render unenforceable such term or provision in any other jurisdiction.

!% . Survival. Provisions of these Terms which by their nature should apply beyond their terms will remain in force after any termination or expiration of this Agreement including, but not limited to, the following provisions: Compliance with Law, Confidential Information, Governing Law, Arbitration, Submission to Jurisdiction for Enforcement and Survival.

Finish Samples - How to Order



Matte Black (-67x)
#13900901



Matte White (-70x)
#13900902



Polished Nickel (-83x)
#13999902



Brushed Nickel (-82x)
#13999903



Polished Gold Optic (-99x)
#13999904



Brushed Gold Optic (-25x)
#13999905



Brushed Bronze (-14x)
#13999909



Polished Black Chrome (-33x)
#13999910



Brushed Black Chrome (-34x)
#13999911



Stainless Steel Optic
(-80x, -86x)
#13999914



Polished Brass (-93x)
#13999912



Brushed Brass (-95x)
#13999913

AXOR dealers should send all purchase order requests to:
orders@hansgrohe-usa.com

AXOR

AXOR North America
1490 Bluegrass Lakes Pkwy
Alpharetta, GA
30004

Tel. 800-334-0455

AXOR-DESIGN.COM

AXOR New Products Price Book 2024-en-US • Part No. 84140152 • Subject to technical alterations and color discrepancies. • © 2023 Hansgrohe, Inc. All rights reserved. • Printed in United States